

BASIC INFORMATION

Straumann iEXCEL™ System -
Guided Surgery System Instruments



ABOUT THIS GUIDE

This guide provides an overview of the instruments required for the Straumann® Guided Surgery Workflow and describes the steps required for guided implant bed preparation and guided placement of implants of the Straumann® Dental Implant system. It is assumed that the user is familiar with placing dental implants. Not all detailed information will be found in this guide. Reference to existing Straumann® procedure manuals will be made throughout this document.

Not all products shown are available in all markets.

CONTENTS

1. THE STRAUMANN® GUIDED SURGERY INSTRUMENTS	3
1.1 Overview of the Straumann® Guided Surgery instruments	3
1.2 Implant bed depth control	4
1.3 coDiagnostiX® surgical protocol	5
2. SURGICAL PROCEDURE	7
2.1 Site preparation	8
2.2 Basic implant bed preparation	9
2.3 Fine implant bed preparation (for BLC and TLC implants only)	10
2.4 Guided implant insertion	11
3. TECHNICAL INFORMATION ON STRAUMANN® GUIDED INSTRUMENTS	13
3.1 Surgical Template and guided instruments	13
3.2 Cutting instruments	19
4. STRAUMANN® DENTAL IMPLANT PORTFOLIO FOR GUIDED SURGERY	25
5. T-SLEEVE POSITION AND IMPLANT LENGTH MATRIX	27
5.1 T-sleeves Ø 5.0 mm	27
5.2 Coronal widening (BLX/TLX)	27
5.3 T-sleeves Ø 2.8 mm (narrow interdental space)	28
5.4 T-sleeves Ø 2.2 mm (pilot guided)	28
5.5 Surgical Cassette for Guided Surgery	29
6. RELATED DOCUMENTS	30
7. ARTICLE LIST – INSTRUMENTS FOR GUIDED SURGERY	31
7.1 Guided Surgery with BLC, TLC, BLX and TLX Implants	31
7.2 Guided Surgery with BLC, TLC, BLX and TLX Implants (single use)	34

1. THE STRAUMANN® GUIDED SURGERY INSTRUMENTS

The Straumann® Guided Surgery instruments are used for guided implant bed preparation and guided placement of dental implants of the Straumann® Dental Implant System.

Cutting instruments for the site and implant bed preparation can be used guided either directly through the Ø5.0 mm T-Sleeve of the Surgical Template (Mucosa Punch), through a Guided Drill Handle (Milling Cutter and Drills) or in conjunction with a Guided Adapter (Profile Drills).

All Straumann BLC™, BLX™, TLC™ & TLX™ implants have a TorcFit™ connection and can be used with the Guided implant driver.

1.1 OVERVIEW OF THE STRAUMANN® GUIDED SURGERY INSTRUMENTS

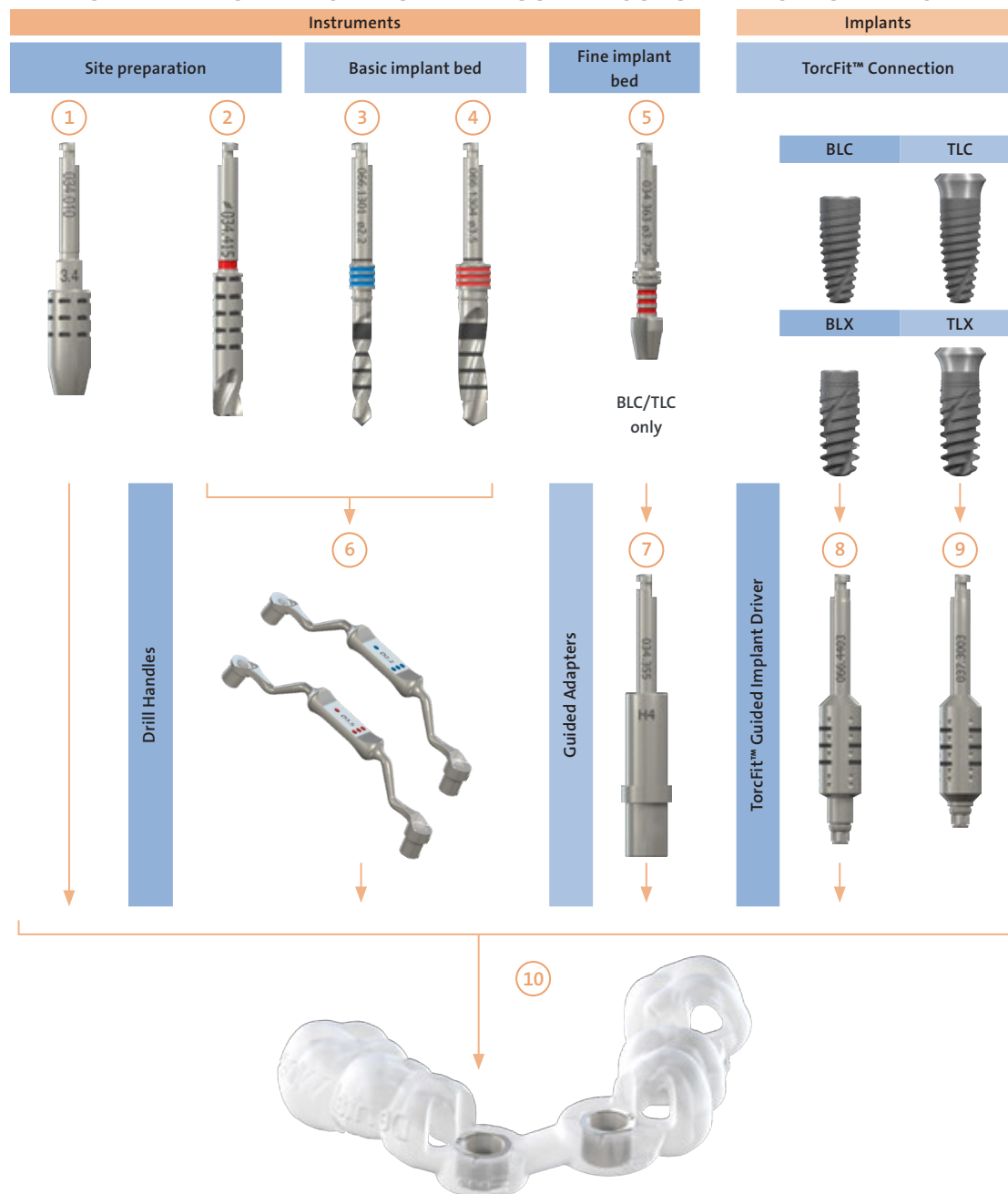

Cutting instruments:

- 1 Mucosa Punch (see page 19)
- 2 Milling Cutter (see page 20)
- 3 Pilot VeloDrill™ Ø2.2 mm (see page 21)
- 4 VeloDrills™ Ø2.8-4.2 mm (see page 21)
- 5 Profile Drill for BLC/TLC – FIBA compatible (see page 23)

Guiding instruments:

- 6 Drill Handles (see page 17)
- 7 Guided Adapter for Profile Drill (BLC/TLC), FIBA (see page 18)
- 8 TorcFit™ BLC/BLX Guided Implant Driver 066.4403
- 9 TorcFit™ TLC/TLX Guided Implant Driver 037.3003 (SP version)
- 10 Surgical Template with Ø5 mm metal T-Sleeve (see page 14)

1.2 IMPLANT BED DEPTH CONTROL

Any desired implant bed depth between 4 mm and 16 mm can be achieved by selecting a specific combination of the T-sleeve position, the Drill Handle cylinder height and the drill lengths.

Flexible T-sleeve position

The T-sleeve can be positioned at 3 different heights, indicated as H2, H4 and H6. The indicated height represents the distance between the T-sleeve and planned final implant position (implant shoulder).

T-sleeve positioning can be determined by the following criteria:

- Mucosal thickness,
- Type of Surgical Template (mucosa, bone or tooth-supported)
- Access for instrument irrigation.

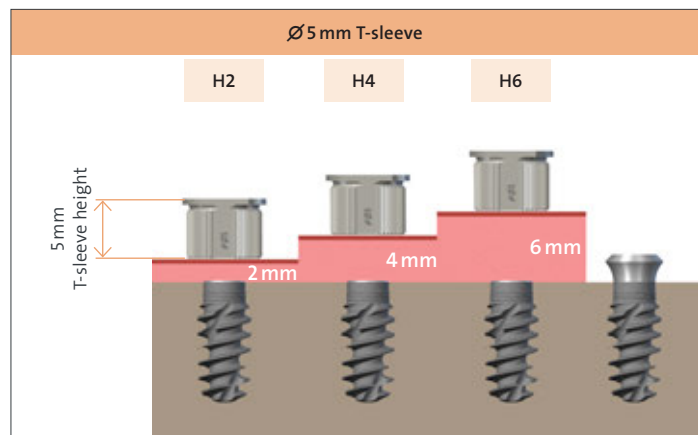

Note: For maximum precision, always select the lowest T-sleeve position possible; T-sleeve contact with tissue must be avoided.

Two different cylinder heights

Straumann® Guided Surgery Drill Handles have two different cylinder heights (1 mm and 3 mm) marked on the instrument with colored dots.

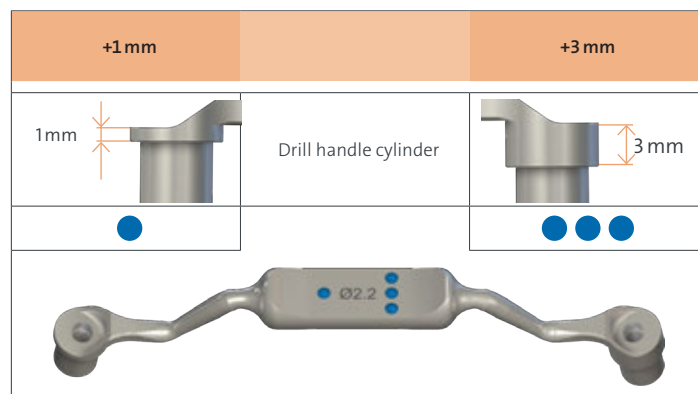

Three different drill lengths



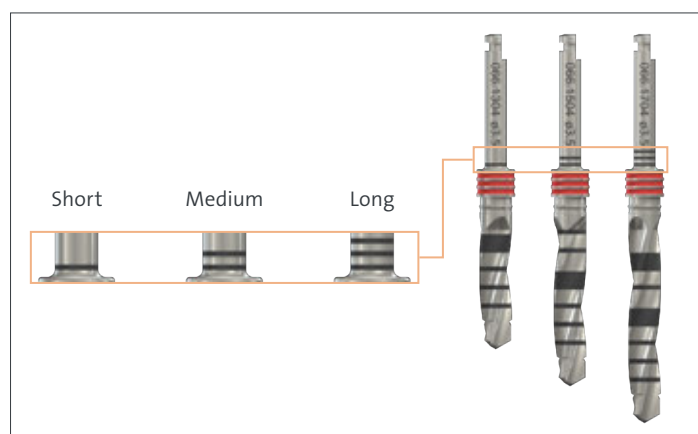

Straumann® Guided Surgery Drills are available in 3 different lengths (short, medium and long). The drill length is indicated on the drill shaft by a laser mark.



1.3 CODIAGNOSTIX® SURGICAL PROTOCOL

coDiagnostiX®, the planning and guide design software from Dental Wings GmbH, Chemnitz (Germany), calculates the surgical protocol based on the virtual planning of implant placement and choice of T-sleeve type and position. The surgical protocol recommends which Drill Handle cylinder (+1mm or +3 mm) and which drill lengths (short, medium, or long) are required for preparing the osteotomy for each specific implant. The Surgical protocols are provided by coDiagnostiX®.

1.3.1 Straumann BLC™, TLC™, BLX™ and TLX™ Implants

Straumann BLX™ implants		Surgical protocol										FDI notation (World Dental Federation)	
Straumann® VeloDrill™ Guided Surgery													
Position	Milling Cutter	Ø2.2 X VeloDrill™	Bone density	Ø2.8 X VeloDrill™	Ø3.2 X VeloDrill™	Ø3.5 X VeloDrill™	Ø3.7 X VeloDrill™	Ø4.2 X VeloDrill™	Ø4.7 X VeloDrill™	Ø5.2 X VeloDrill™	Ø6.2 X VeloDrill™	Implant	Depth Stop
32	Ø 3.5		soft/D4 medium/D2-D3 hard/D1									061.5312 BLX RB Ø 4 12 mm SLActive®	H6

Above is an example of a surgical protocol for a Straumann BLX™ Ø 4.0/12 mm on tooth position 32, with a selected T-sleeve position at H6. The recommended drills (Ø and color code) and the required combination of cylinder height (dots) and drill length (lines) are indicated in the table. A “c” in the dots means that this drill step should be used for coronal widening only (see *Widen coronal bone* on page 10).

The example on the next page can be used to calculate manually the required combination of Drill Handle cylinder height and implant length in case of an intraoperative change of the implant length.

For more information please refer to <https://www.codiagnostix.com>.

Example of how to achieve an implant bed depth for a 10 mm implant

For guided implant bed preparation using a 10 mm Straumann® Implant, T-sleeve position H2 and H6 can be used. The following examples show how the different components of the Straumann® Guided Surgery System fit together to achieve a 10 mm implant bed depth.

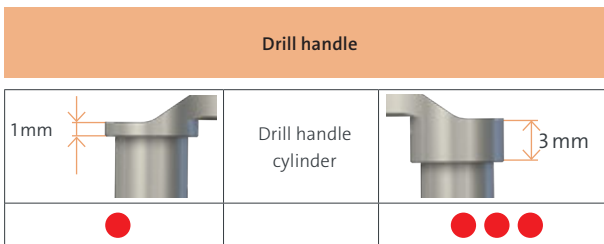
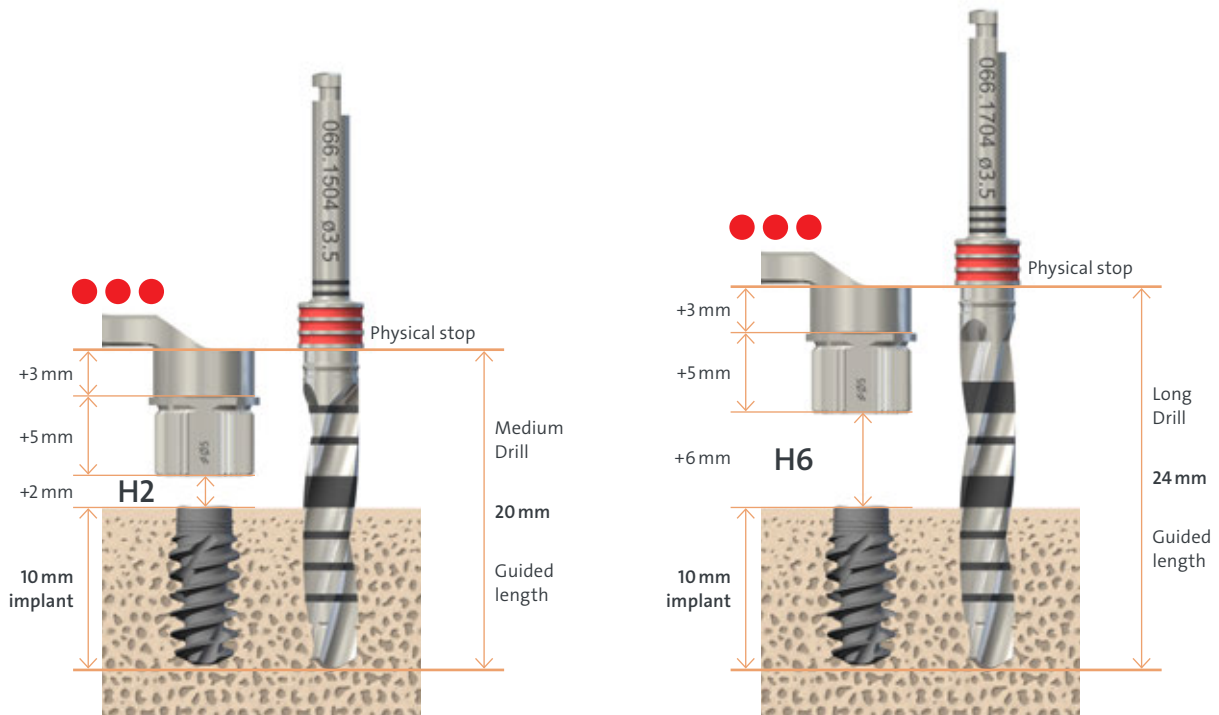

Drill name	Guided length	Overall length	Symbol for drill length
Short	16 mm	34 mm	—
Medium	20 mm	38 mm	=
Long	24 mm	42 mm	≡

For more information please refer to Chapter 5. *T-sleeve position/implant length matrix* on page 27.

2. SURGICAL PROCEDURE

After receiving the Surgical Template from the manufacturer and prior to starting any surgical procedure, evaluate the fit and stability on the model and in the patient's mouth as well as the size and location of the openings for irrigation. Verify that the position and orientation of the T-sleeves in the Surgical Template match the preoperative plan and surgical protocol and also verify that the right Drill Handles to fit into the selected T-sleeves are available.

For more information please refer to Chapter 3. *Technical information on Straumann® guided instruments* on page 13.

The Straumann® Guided Surgery workflow offers guided pilot drilling or fully guided surgery which included guided implant bed preparation and guided implant placement.

Guided pilot drilling

For guided pilot drilling, only the $\varnothing 2.2$ mm pilot drill is needed. The dedicated “ $\varnothing 2.2$ mm T-sleeves for guided pilot drilling” allow the use of the drill without drill handles.

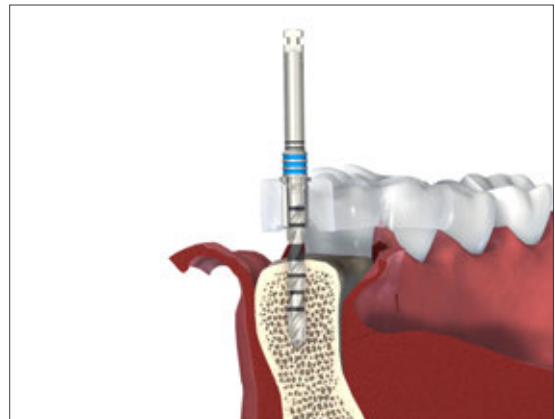

Fully guided surgery

The Straumann® $\varnothing 5.0$ mm T-sleeve is used for fully guided drilling and implant placement, suiting implant diameters of between $\varnothing 3.3$ mm and $\varnothing 4.5$ mm, it is also compatible with the Straumann® Guided Surgery Drill Handles, the Guided Adapters and the Guided Implant Drivers

For implants wider than 4.5 mm, the implant bed can be pre-drilled up to $\varnothing 4.2$ mm, and then the sequence can be finished freehand.

A $\varnothing 2.8$ mm T-sleeve is also available for narrow interdental spaces, which allows guided drilling with the $\varnothing 2.8$ mm drills without the use of a Drill Handle.

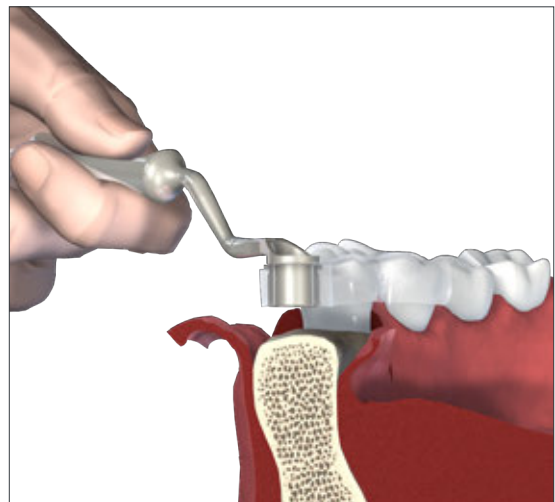

The Surgical Template can be bone, mucosa or tooth-supported, depending on the clinician's preferences and the planning system used. A variety of fixation pins are available for additional stabilization of the Surgical Template. Refer to Chapter 3.1 *Surgical Template and guided instruments* on page 13 for detailed instructions.

2.1 SITE PREPARATION

Mucosa Punch for flapless surgery

The Mucosa Punch can be used through the \varnothing 5.0 mm T-sleeves to punch through the gingiva for surgical access.

The three depth marks indicate the distance from bone level to the top of the rim of the respective T-sleeve (H2, H4, H6).

For more information please refer to Chapter 3.2.1 *Mucosa Punch* on page 19.

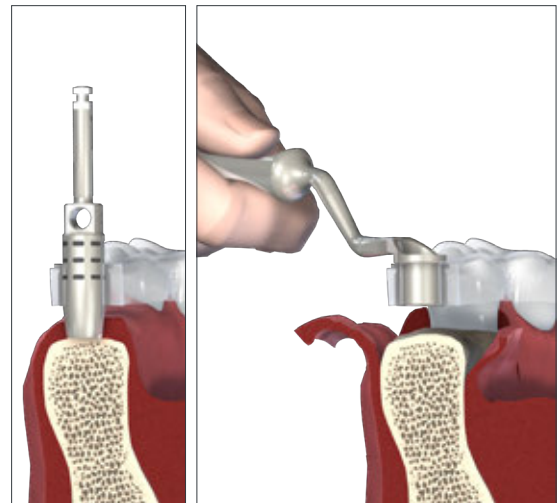

Flattening the alveolar ridge

The Milling Cutter can be used to create a flat bone surface. Choose the Milling Cutter and corresponding Drill Handle as indicated in the surgical protocol.

Use the laser markings set at 2 mm intervals on the Milling Cutter for depth reference.

Note: Milling Cutters have no physical stop. Milling Cutters may only be used for flattening the alveolar ridge.

For more information please refer to Chapter 3.2.2 *Milling Cutter* on page 20.

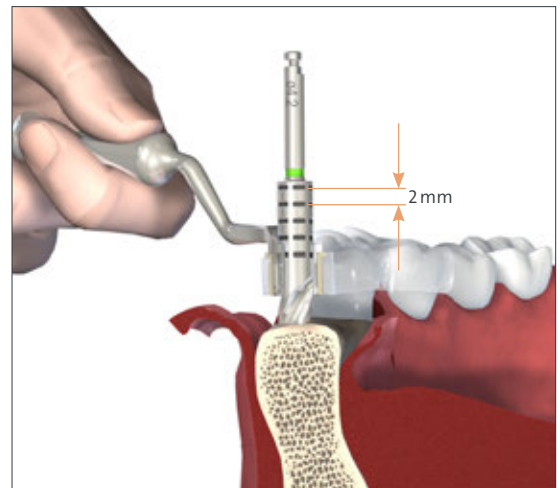

2.2 BASIC IMPLANT BED PREPARATION

For the basic implant bed preparation Straumann® guided drills are used in combination with Drill Handles to achieve the desired implant bed depth.

Always make sure to use the correct Drill Handle cylinder (+1 mm (one dot) or +3 mm (3 dots)) and the corresponding drill length (short, medium, or long) as indicated in the surgical protocol.

Start drilling only after fully inserting the drill into the cylinder of the Drill Handles.

Pilot drilling

Pre-drill the implant bed at no more than 800 rpm with the \varnothing 2.2 mm Pilot Drill using the corresponding Drill Handle (blue) for guidance. Drill until the physical stop of the guide drill reaches the Drill Handle cylinder to achieve the required osteotomy depth.

Before continuing with the implant bed preparation, determine the bone class at the implant bed site with the appropriate method.

Subsequently, follow the surgical protocol to complete the basic implant bed preparation. For further information on the surgical procedure of the Straumann® Dental Implant System, please refer to the respective Basic Information (See Chapter 6. *Related documents*)

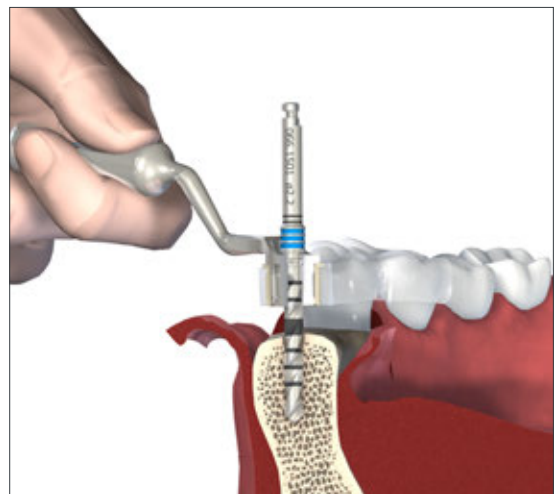

Vertical Template Fixation Pins can then be used for further stabilization of the Surgical Template (see Chapter 3.1.3 *Vertical Template Fixation Pins* on page 15).

Note: The widest handle is compatible with the \varnothing 4.2 mm guided drill. For cases that require wider drills (\varnothing 4.7, 5.2, or 6.2 mm), pre-drill guided to \varnothing 4.2 mm, remove the template and follow the conventional workflow.

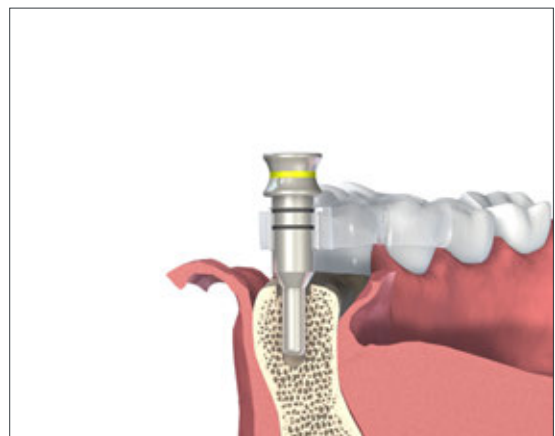

Widen coronal bone (for BLX and TLX implants only)

For Straumann BLX™ and TLX™ implants, the coronal segment of medium and hard bone should be widened before implant placement, if indicated by the protocol. The drill size in brackets or marked with a "c" is used for depths of 4 mm (for implant lengths of 6 mm and 8 mm) and 6 mm (for implant lengths of 10 mm and longer) for widening the coronal segment of the implant bed.

Note: Avoid planning Straumann BLX™ and TLX™ implant with a length of 6 mm and 8 mm in the T-sleeve position H2, since 4 mm of guided drilling is not possible in the H2 position. If cortical widening is needed in a site with a T-sleeve in H2 position, remove the template and perform the coronal drilling using conventional procedures. For an overview, see table in chapter 5.2 on page 27.

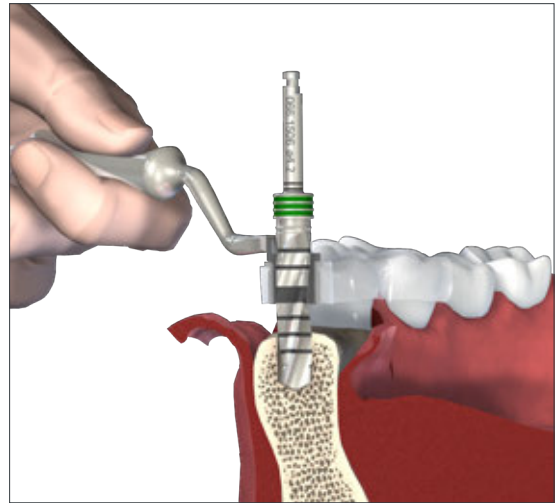

Caution:

- Inspect the instruments for operational reliability prior to each surgery and replace if necessary. Avoid lateral pressure on instruments that may damage the instruments themselves, the handle cylinder or the T-sleeve.
- Cutting instruments must not rotate during insertion into, or removal from, T-sleeves or handles.
- Use intermittent drilling with ample cooling of cutting instruments using pre-cooled sterile physiological saline solution.

2.3 FINE IMPLANT BED PREPARATION (FOR BLC AND TLC IMPLANTS ONLY)

Fine implant bed preparation includes profile drilling. The procedure depends on implant type. Fine implant bed preparation is not needed for Straumann BLX™ and TLX™ implants.

2.3.1 Profile drilling

Profile drilling prepares the implant bed for the shape of a specific Straumann® implant. Choose the correct Guided Adapter for profile drill (FIBA-Fine Implant Bed Adapters) according to the T-sleeve position (H2, H4, H6).

Insert the assembled Adapter and profile drill into the Ø5.0 mm T-sleeve. Shape the coronal part of the implant bed with the corresponding guided profile drill and the recommended speed of 300 rpm.

Always drill until the **physical stop** of the Adapter hits the T-sleeve to reach the required depth.

For more information please refer to Chapter 3.1.6 *Guided Adapter for profile drills, FIBA* on page 18 and Chapter 3.2.4 *Profile Drills, FIBA compatible* on page 23.

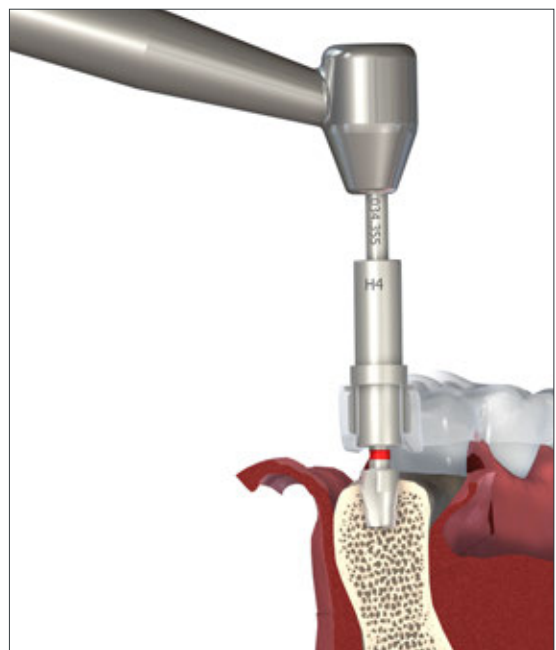

2.4 GUIDED IMPLANT INSERTION

Guided implant placement can be used to maximize precision. The implant can be inserted through Straumann® Ø5.0 mm T-sleeves using either visual depth control for all Straumann® implants with the TorcFit™ connection (e.g. BLC, TLC, BLX, TLX) or physical depth control with the Stop Key for Straumann BLC™ and BLX™ implants.

Alternatively, remove the Surgical Template and place the implant using the conventional procedure without Surgical Templates as described on the surgical procedure of the Straumann® Dental Implant System, please refer to the respective Basic Information (See Chapter 6. *Related documents*).



Note: The H4 or H6 T-sleeve position is recommended when planning to use guided Implant placement to ensure sufficient guiding contact between the Guided Adapter or the Guided Implant driver and the T-sleeve.

Note: After removing the implant from the solution, the SLActive® surface treatment is chemically active for 15 minutes.

2.4.1 Guided implant insertion with a Guided Implant Driver (TorcFit™ Connection)

Pick up the implant from the vial and insert at a maximum clockwise speed of 15 rpm. The final implant position is indicated by the visual stop marks according to the planned T-sleeve position (H2, H4, H6) on the implant driver (pictures 1 and 3).

For the screw-retained guided implant drivers, a Stop Key (art. no. 034.006) can be used for a physical stop to indicate the final implant position. Use the Stop Key with the flat side pointing towards the T-sleeve (picture 2).

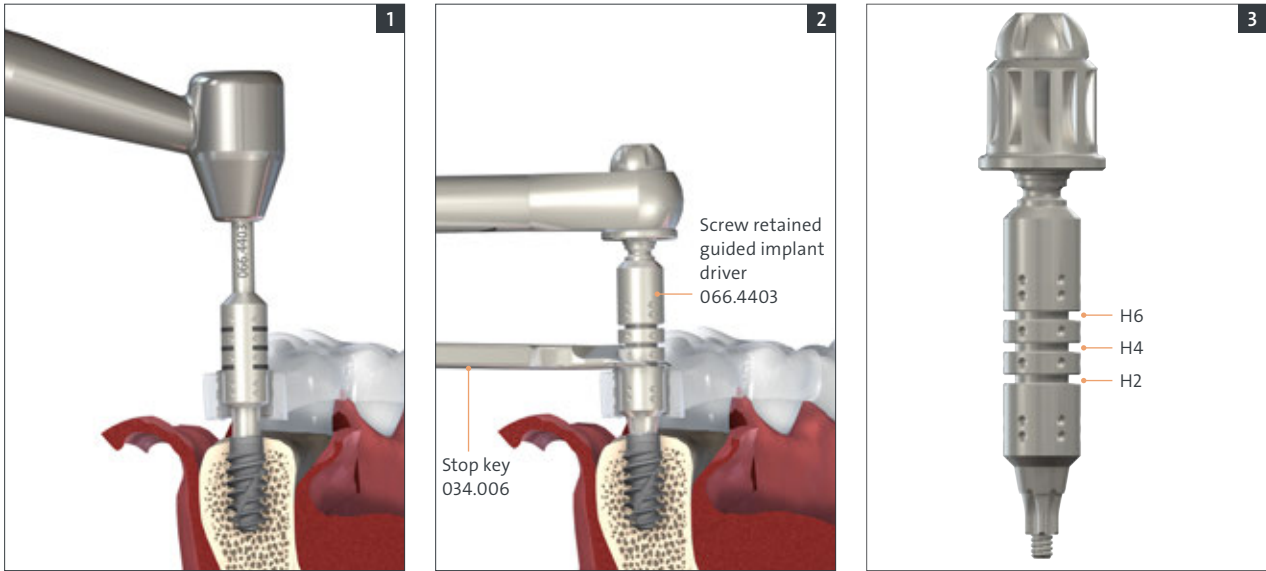

For Straumann BLX™ and TLX™, if strong resistance is encountered before the implant reaches its final position, rotate the implant counterclockwise a few turns and continue to insert. Repeat this step several times if necessary.

For all implants, if the resistance is still too high, remove the implant, place the implant and implant driver back in the vial and widen the implant bed according to the drill protocol.

Guided indexing (if applicable)

The indexing marks on the Drill Guide indicate where to align the rotational marker of the insertion tool to achieve the planned position of the prosthetic components.

Once the implant is placed, gently pull the Guided Implant Driver out vertically. For a screw-retained Guided Implant Driver, loosen the fixation screw and gently pull out vertically.

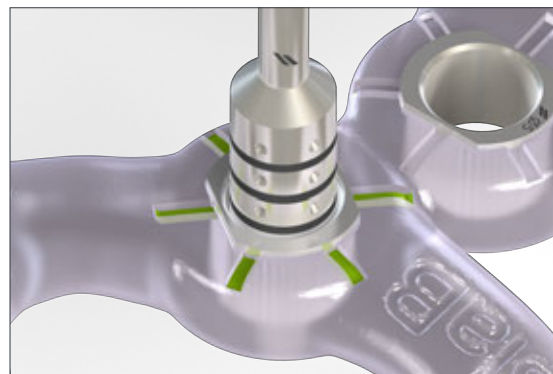

Note:

- After removing the implant from the solution, the SLActive® surface treatment is chemically active for 15 minutes.
- With Straumann® guided instruments, increased insertion torques can occur due to precise osteotomy preparation.
- For immediate loading, a final torque of at least 35 Ncm should be achieved
- Excessive insertion torque must be avoided because this can lead to over-compression of the bone.

3. TECHNICAL INFORMATION ON STRAUMANN® GUIDED INSTRUMENTS

3.1 SURGICAL TEMPLATE AND GUIDED INSTRUMENTS

3.1.1 Surgical Template

Bone, mucosa or tooth-supported Surgical Templates (see figures) can be used depending on the clinician's preferences and the planning system used.

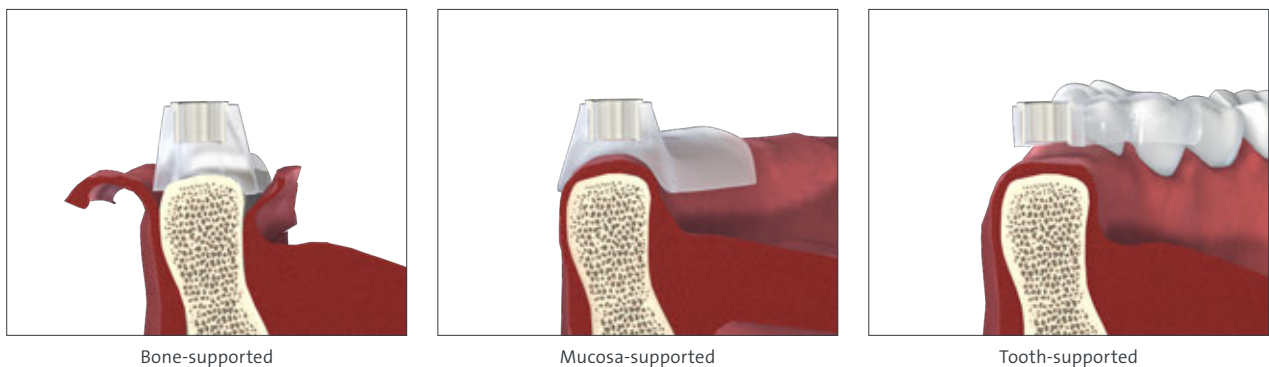

The Surgical Template must allow for proper irrigation of the surgical site. Windows may also be included in the Surgical Template. For a correct fit of the handle cylinder in the T-sleeve, remove additional material around the T-sleeve.

Caution:

- Ensure the T-sleeve is firmly fixed in the Surgical Template.
- Ensure the T-sleeve is fully seated in the template, with the rim in contact with the template.
- Radial and axial loads on the T-sleeve must be avoided to help ensure proper retention of the T-sleeves in the Surgical Template.
- On receipt of the Surgical Template from the manufacturer and prior to starting any surgical procedure, evaluate its fit and stability on the model and in the patient's mouth as well as the size and location of the openings for irrigation. Verify that the position and orientation of the T-sleeve in the Surgical Template match the preoperative plan and also verify that the right Drill Handles to fit into the selected T-sleeves are available (round or self-locking). Check product documentation if provided by the Surgical Template manufacturer.

3.1.2 T-sleeve types

Depending on the anatomical situation and the planned axis of adjacent implants, different T-sleeve diameters are available, for maximum precision use a metal T-Sleeve.







Article	Picture	Sleeve inner diameter	Sleeve outer diameter	Sleeve height	Need of Drill handle	Art. No./ material
Ø5 mm T-sleeve		d = 5 mm	Dmin = 5.7 mm Dcollar = 7.0 mm Dmax = 6.3 mm	H = 5 mm h = 4.5 mm	Yes	034.053V4 stainless steel
Ø2.8 mm T-sleeve		d = 2.8 mm	Dmin = 3.2 mm Dcollar = 4.4 mm Dmax = 3.8 mm	H = 6 mm h = 5.5 mm	No	034.055V4 stainless steel
Ø2.2 mm T-sleeve		d = 2.2 mm	Dmin = 2.6 mm Dcollar = 3.8 mm Dmax = 3.2 mm	H = 6 mm h = 5.5 mm	No	046.712V4 stainless steel

For more information go to Chapter 3.1.5 *Drill Handle* on page 17.

3.1.3 Vertical Template Fixation Pins

Vertical Template Fixation Pins can be used to stabilize the Surgical Template and prevent the cantilever effect while drilling multiple implant beds.

The pins are inserted after basic implant bed preparation is complete. A pin can be inserted into the implant bed socket to stabilize the guide before drilling the second implant site.

Orientation	Article	Sleeve type	Picture	Pin Diameter (mm)	Article No.
Vertical	Template fixation pins	Ø 2.8 mm T-sleeve 034.055V4 034.052V4		Ø 2.8/2.8	034.298
				Ø 5/2.8	034.285
		Ø 5 mm T-sleeve 034.053V4 034.299V4 034.050V4		Ø 5/3.2	034.286
				Ø 5/3.5	034.287
				Ø 5/3.7	034.288
				Ø 5/4.2	034.289

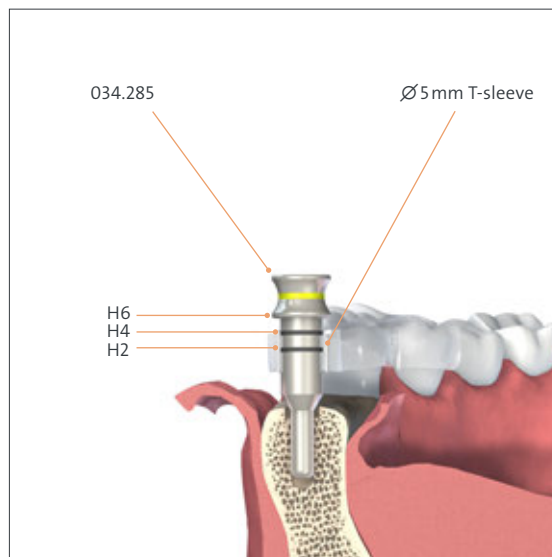

Vertical Template Fixation Pins have a visual depth mark corresponding to the selected T-sleeve position.



Caution: In case of flapless surgery, no force may be applied onto the Template Fixation Pins to avoid damage to the soft tissue. Secure the pins against aspiration.

3.1.4 Lateral Template Fixation Pins

Lateral Template Fixation Pins can be used to stabilize the guide where there is sufficient bone of adequate quality. The number of pins must be adapted to the anatomy, type of template and position of implants.

Orientation	Article	Sleeve type	Picture	Pin Diameter (mm)	Article No.
Lateral	Template Fixation Tools	T-sleeve for fixation pin 034.283	 Template fixation pin	Ø1.3	034.282
			 Drill for template fixation pin		034.284

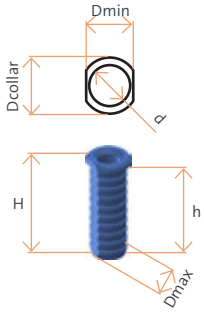
Article	Picture	Sleeve inner diameter	Sleeve outer diameter	Sleeve height	Need of drill handle	Art. No.
T-sleeve for Ø1.3 mm Template Fixation Pin		d = 1.35 mm	Dmin = 2.2 mm Dcollar = 3.1 mm Dmax = 2.5 mm	H = 7.5 mm h = 7 mm	No	034.283

To insert the pins, a T-sleeve for Template Fixation Pin (art. no. 034.283) and Drill for Template Fixation Pin (art. no. 034.284) are used.

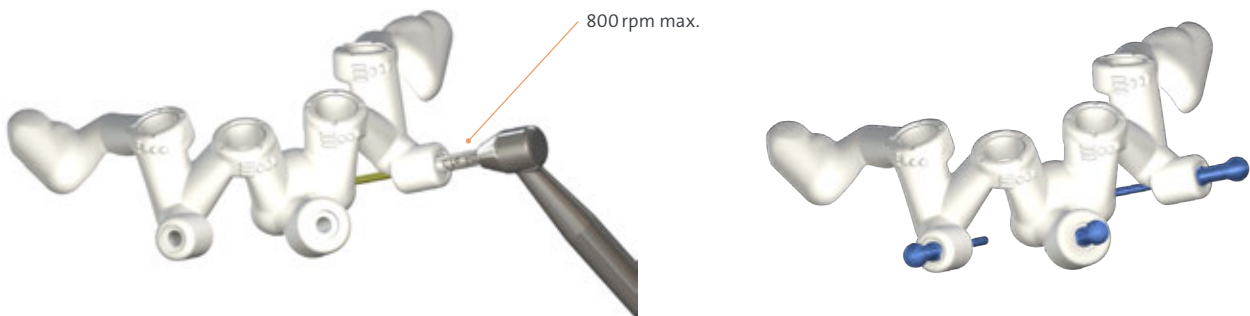

The number of pins must be adapted to the anatomy, type of template and position of implants. For examples of recommended positions, see figure below.

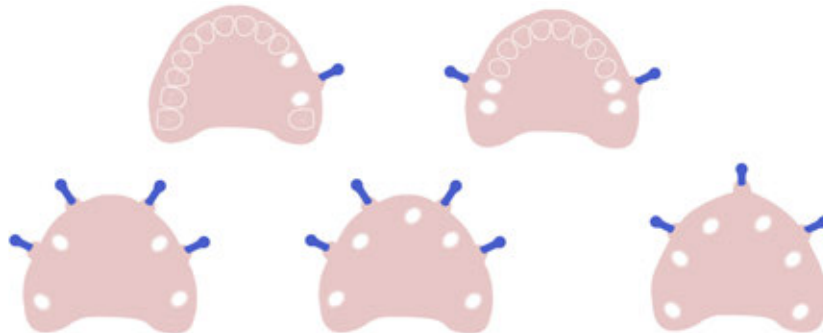

3.1.5 Drill Handle



For identification during surgery, Straumann® Guided Surgery Drill Handles are color-coded and marked with symbols for the respective cylinder height (one dot for 1 mm, 3 dots for 3 mm).

Article	Picture	Art. No.
Drill handle, Ø 2.2 mm, 1 mm/3 mm		026.0147
Drill handle, Ø 2.8 mm, 1 mm/3 mm		026.0148
Drill handle, Ø 3.2 mm, 1 mm/3 mm		026.0149
Drill handle, Ø 3.5 mm, 1 mm/3 mm		026.0150
Drill handle, Ø 3.7 mm, 1 mm/3 mm		026.0151
Drill handle, Ø 4.2 mm, 1 mm/3 mm		026.0152

The planning software calculates the surgical protocol (see chapter 1.3 on page 5) based on the virtual planning of implant placement and choice of T-sleeve types and positions. The surgical protocol recommends which Drill Handle cylinder (+1 mm or +3 mm) and which drill length (short, medium, or long) are required for preparing the osteotomy for each specific implant.

3.1.6 Guided Adapter for profile drills, FIBA

Guided Adapters for profile drills (FIBA – Fine Implant Bed Adapters) are designed to work with FIBA-compatible short profile drills. These FIBA-compatible profile drills can be used in freehand cases, or in guided cases when used in conjunction with a Guided Adapter.

Article	Picture	Sleeve position	Art. No.
Guided Adapter for Profile Drill, FIBA, H2, handpiece, stainless steel		H2	034.354
Guided Adapter for Profile Drill, FIBA, H4, handpiece, stainless steel		H4	034.355
Guided Adapter for Profile Drill, FIBA, H6, handpiece, stainless steel		H6	034.356

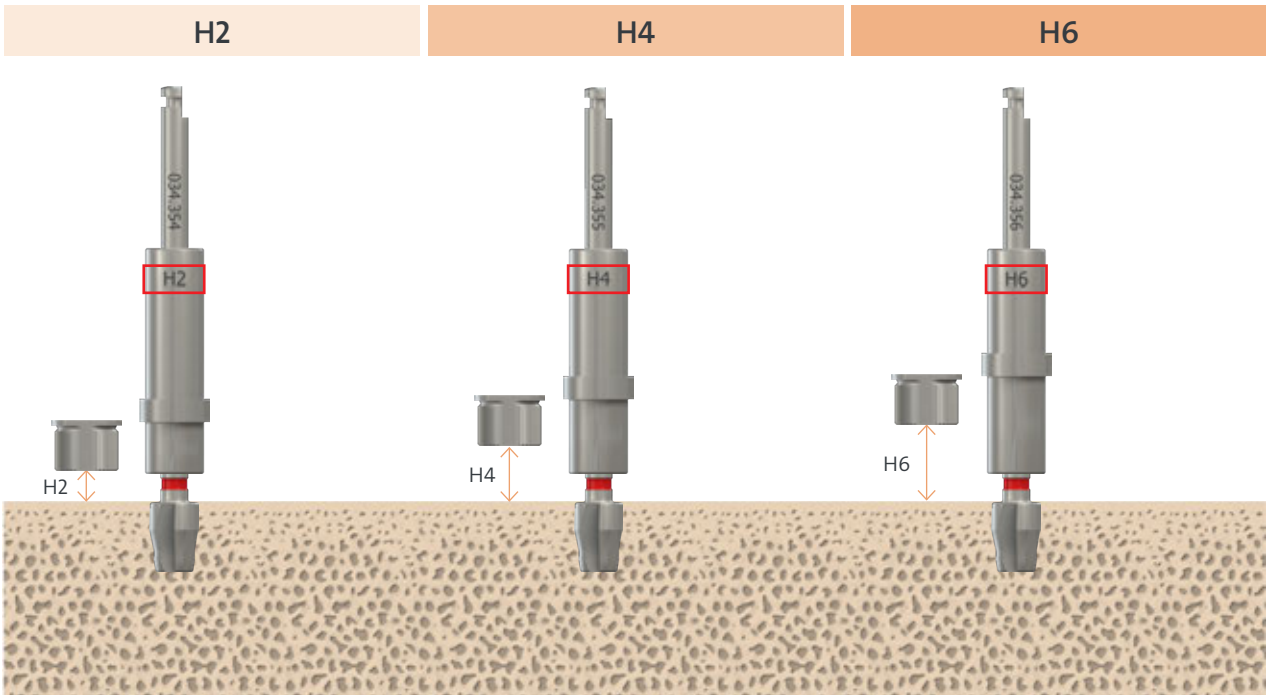

The Guided Adapters are laser-marked with the corresponding T-sleeve position (H2, H4, H6). Use the correct adapter according to the selected T-sleeve position as shown in the chart below.



3.2 CUTTING INSTRUMENTS

3.2.1 Mucosa Punch

For flapless surgery, the Mucosa Punch can be used through the 5.0 mm T-sleeve to punch through the gingiva for surgical access. The following table lists the mucosa punches available and their specifications.

Article name	Picture	Max rpm.	Art. No.
Mucosa Punch, \varnothing 3.4 mm, guided		15	034.010
Mucosa Punch, \varnothing 4.0 mm, guided			034.011
Mucosa Punch, \varnothing 4.7 mm, guided			034.012

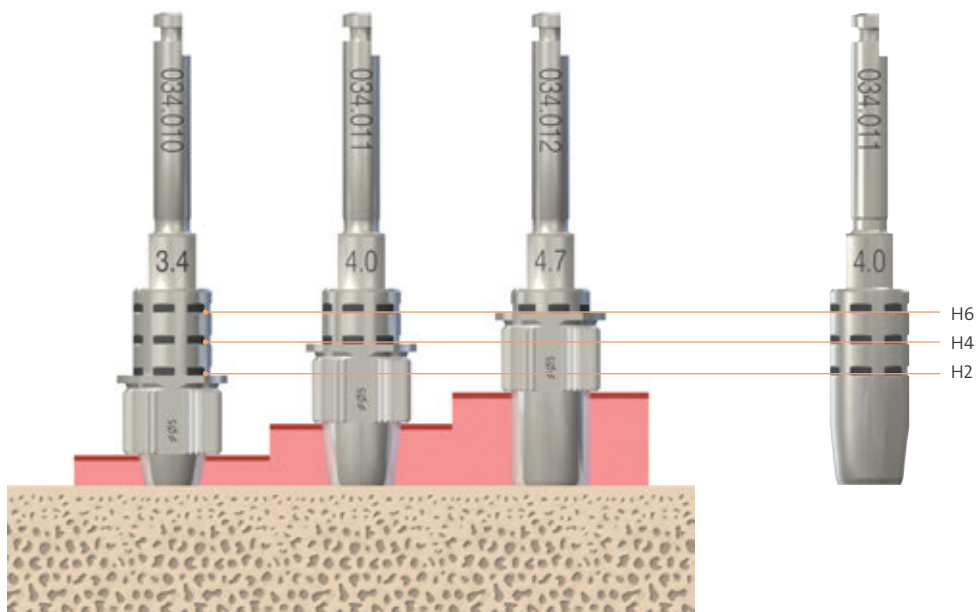

3.2.2 Milling Cutter

Milling Cutter are to be used to create a flat bone surface and a sufficiently wide area of bone. The following table lists the Milling Cutter to be selected for each implant bed.

Note: Milling cutters have no stop. Milling cutters must only be used for flattening the alveolar ridge.

Article Name	Picture	Max rpm.	Endosteal implant diameter (mm)	Art. No.
Milling Cutter, Ø2.2 mm, guided		800	Ø2.9	026.0144
Milling Cutter, Ø2.8 mm, guided		600	Ø3.3 Ø3.5	034.215
Milling Cutter, Ø3.5 mm, guided		500	Ø3.75 Ø4.0 Ø4.1	034.415
Milling Cutter, Ø4.2 mm, guided		400	Ø4.5 Ø4.8	034.615

Choose the Milling Cutter and corresponding drill handle as indicated in the surgical protocol. Place the cylinder of the drill handle into the Sleeve in the surgical template. Insert the Milling Cutter into the cylinder until it contacts bone level. Prepare the alveolar ridge to the intended depth with the Milling Cutter. Use the 2 mm intervals laser-marked on the Milling Cutter as a depth reference.

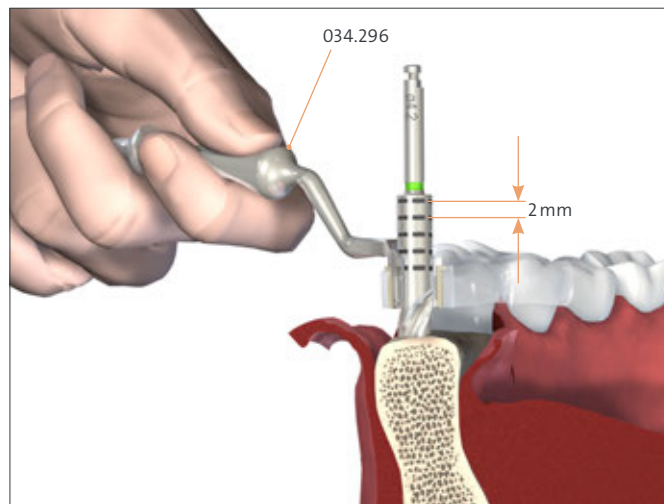

* The Ø4.2 mm Drill Handle and corresponding Ø4.2 mm Milling Cutter are shown as an example.







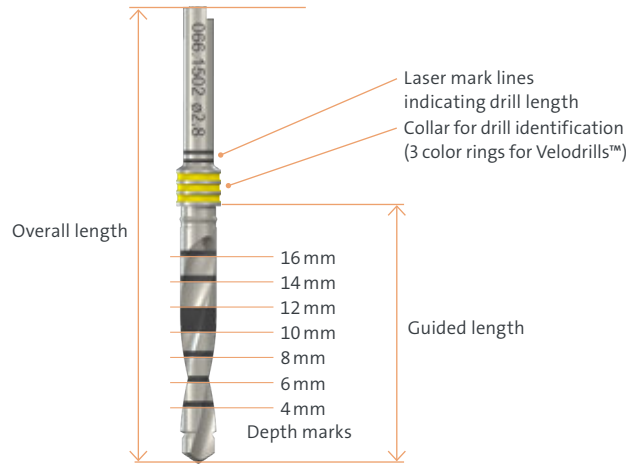

3.2.3 Velodrills™

Straumann® guided drills are color-coded by diameter and laser mark on the shaft to indicate their guided length (see figure below).

Drill name	Guided length	Overall length	Symbol for drill length
Short	16 mm	34 mm	—
Medium	20 mm	38 mm	=
Long	24 mm	42 mm	≡

























Color coding and labeling of Straumann® cutting instruments for guided surgery:

Color-coding guided instruments		
Color sequence		Instrument diameter
	blue	∅2.2 mm
	yellow	∅2.8 mm
	white	∅3.2 mm
	red	∅3.5 mm
	grey	∅3.7 mm
	green	∅4.2 mm
	magenta	∅4.7 mm
	brown	∅5.2 mm
	black	∅6.2 mm

Guided surgery compatible

Freehand only







Straumann® VeloDrill™, for freehand and guided

Article	Picture	Length	Symbol	Max rpm.	Art. No.
Pilot VeloDrill™, guided, Ø 2.2 mm		short	—	800	066.1301
		medium	≡		066.1501
		long	≡≡		066.1701
VeloDrill™, guided, Ø 2.8 mm		short	—		066.1302
		medium	≡		066.1502
		long	≡≡		066.1702
VeloDrill™, guided, Ø 3.2 mm		short	—		066.1303
		medium	≡		066.1503
		long	≡≡		066.1703
VeloDrill™, guided, Ø 3.5 mm		short	—		066.1304
		medium	≡		066.1504
		long	≡≡		066.1704
VeloDrill™, guided, Ø 3.7 mm		short	—		066.1305
		medium	≡		066.1505
		long	≡≡		066.1705
VeloDrill™, guided, Ø 4.2 mm		short	—		066.1306
		medium	≡		066.1506
		long	≡≡		066.1706
VeloDrill™, guided, Ø 4.7 mm		short	—		066.1307
		long	≡≡	066.1707	
VeloDrill™, guided, Ø 5.2 mm		short	—	066.1308	
VeloDrill™, guided, Ø 6.2 mm		short	—	066.1309	

Note: The cutting geometry of the Straumann® VeloDrill™ guided has been optimized to create less heat during drilling, therefore a universal drill speed of 800 rpm for all diameter is recommended.

3.2.4 Profile Drills, FIBA compatible

Only profile drills labeled to be FIBA compatible are to be used with the Guided Adapter for profile drills, FIBA. Always use the correct Guided Adapter according to the T-sleeve position (H2, H4, H6). Using the incorrect Guided Adapter or non-FIBA compatible profile drills may cause incorrect drilling depth.

Article	Picture	Max rpm.	Art. No.
BLC/TLC Profile Drill, short, FIBA compatible, \varnothing 3.3 mm, L 27 mm, stainless steel		300 rpm	034.362
BLC/TLC Profile Drill, short, FIBA compatible, \varnothing 3.75 mm, L 26 mm, stainless steel			034.363
BLC Profile Drill, short, FIBA compatible, \varnothing 4.0 mm, L 26 mm, stainless steel			034.364
BLC/TLC Profile Drill, short, FIBA compatible, \varnothing 4.5 mm, L 26 mm, stainless steel			034.365
BLC Profile Drill, short, \varnothing 5.0 mm, L 26 mm, stainless steel			034.382
BLC/TLC Profile Drill, short, \varnothing 5.5 mm, L 26 mm, stainless steel			034.366
BLC/TLC Profile Drill, short, \varnothing 6.5 mm, L 26 mm, stainless steel			034.367

Use tweezers (e.g. art. no.046.820) or Stop Key (art. no. 034.006) to engage and disengage the profile drill with the Guided Adapter to avoid touching the cutting part of the profile drill.





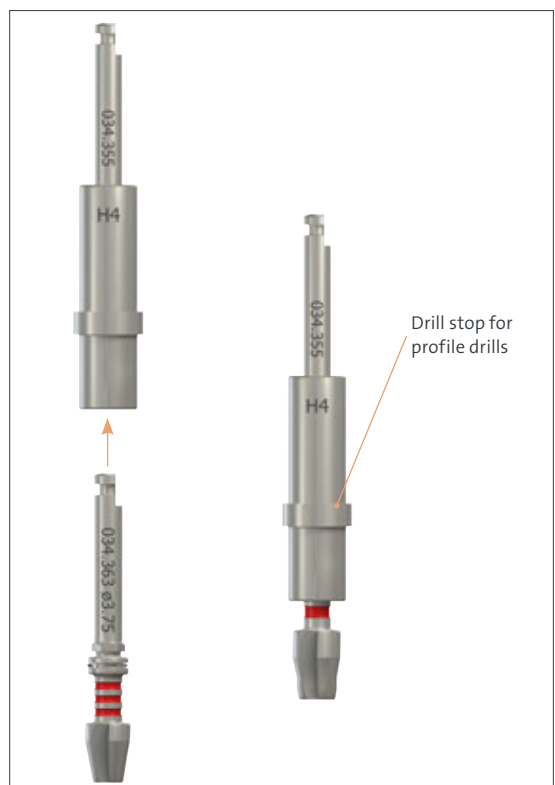



When the profile drill is inserted into the octagonal connection part in the Guided Adapter, there is an audible click as it engages. Shape the coronal part of the implant bed with the corresponding profile drill at the recommended max rpm speed. Always drill until the collar of the Guided Adapter hits the T-sleeve in order to reach the required depth.



3.2.5 Guided Implant Driver

The Guided Implant Driver has depth marks for the H2, H4 and H6 T-sleeve positions. Before implant placement, consult the surgical protocol and confirm that the T-sleeve position matches the implant site. The laser markings on the guided implant drivers are provided for identification. Please be aware that the correct guided implant drivers must be used for the corresponding implant type (S TLX, SP TLX, BLX). Using the wrong type could result in implant placement deeper than planned.

Art. No.	Picture	Article	Compatibility
037.3000		TLC, TLX Guided Implant Driver, ratchet, S	TLC, TLX, S
037.3001		TLC, TLX Guided Implant Driver, handpiece, S	
037.3002		TLC, TLX Guided Implant Driver, ratchet, SP	TLC, TLX, SP
037.3003		TLC, TLX Guided Implant Driver, handpiece, SP	
066.4404		BLC, BLX Guided Implant Driver, ratchet	BLC, BLX
066.4403		BLC, BLX Guided Implant Driver, handpiece	
066.4401		BLC, BLX Guided Implant Driver, ratchet, screw-retained	

Implant pick-up

The Straumann BLC™, BLX™, TLC™, TLX™ Implants are provided with an implant carrying system that supports direct pick-up with an appropriate Implant Driver.

Step 1 – Hold the vial lid and connect the Implant Driver to the implant using the handpiece. You hear a click when the Driver is attached correctly.

Caution: Make sure that the implant driver is properly seated and pull slightly on the driver to verify that it is correctly attached. Replace the driver with a new one if insufficient attachment occurs.

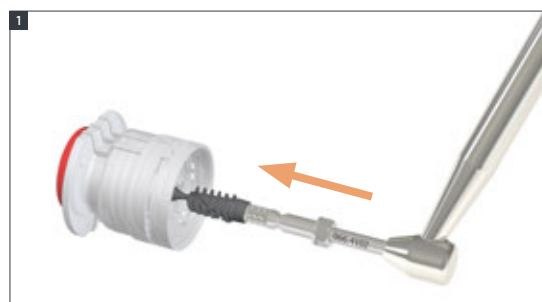

Step 2 – A slight clockwise turn is needed to remove the implant from its holder.

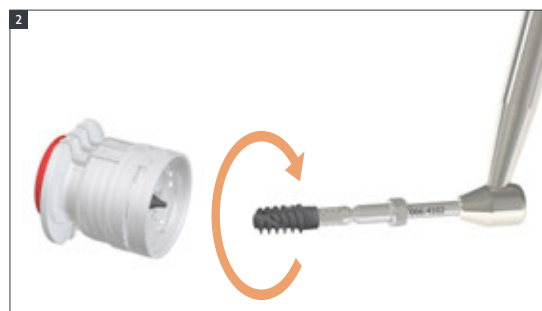

Stop Key

For the Straumann BLC™, BLX™ screw-retained Guided Implant Driver for Ratchet (066.4401), a Stop Key (034.006) can be used for a physical stop to indicate the final implant position. Use the Stop Key with the flat side pointing towards the T-sleeve.

Art. No.	Picture
034.006	







4. STRAUMANN® DENTAL IMPLANT PORTFOLIO FOR GUIDED SURGERY







The following table provides the overview of the Straumann® dental implant portfolio.







- Implants colored in **green** are compatible with the fully guided workflow.
- Implants colored in **blue** are too wide to fit through the $\varnothing 5.0$ mm T-sleeves. Remove the Surgical Template after guided implant bed preparation and place the implant freehand.
- Implant colored in **yellow** offer guided pilot drilling only.







For short implants (6 mm) and long implants (14 mm and 16 mm) not all T-sleeve positions are possible; available positions are indicated in the table (refer to Chapter 5. *T-sleeve position/implant length matrix* on page 27).

18 mm long implants cannot be placed using guided surgery.

TLC Implants	NT		RT		WT	
	$\varnothing 3.5$ mm	$\varnothing 4.8$ mm	$\varnothing 4.8$ mm		$\varnothing 6.5$ mm	
						
	SP $\varnothing 3.3$ NT	SP $\varnothing 3.3$ RT	SP $\varnothing 3.75$ RT	SP $\varnothing 4.5$ RT	SP $\varnothing 4.5$ WT	SP $\varnothing 5.5$ WT
6 mm						
8 mm						
10 mm						
12 mm						
14 mm						
16 mm	H2	H2	H2	H2	H2	H2
18 mm	18 mm implants cannot be placed guided					

TLX Implants Standard TLX Implants Standard Plus	NT	RT	NT	RT	WT*	
	$\varnothing 3.5$ mm	$\varnothing 4.8$ mm	$\varnothing 3.5$ mm	$\varnothing 4.8$ mm	$\varnothing 6.5$ mm	
						
	S/SP $\varnothing 3.5$ NT	S/SP $\varnothing 3.75$ RT	S/SP $\varnothing 4.5$ NT	S/SP $\varnothing 4.5$ RT	S/SP $\varnothing 5.5$ WT	S/SP $\varnothing 6.5$ WT
6 mm						
8 mm						
10 mm						
12 mm						
14 mm						
16 mm	H2	H2	H2	H2		
18 mm	18 mm implants cannot be placed guided					

BLC Implants	RB			WB			
	Ø 3.3 mm	Ø 3.75 mm	Ø 4.0 mm	Ø 4.5 mm	Ø 5.0 mm	Ø 5.5 mm	Ø 6.5 mm
							
	BLC Ø 3.3	BLC Ø 3.75	BLC Ø 4.0	BLC Ø 4.5	BLC Ø 5.0	BLC Ø 5.5	BLC Ø 6.5
6 mm							
8 mm							
10 mm							
12 mm							
14 mm	H2/H4	H2/H4	H2/H4	H2/H4	H2/H4	H2/H4	H2/H4
16 mm	H2	H2	H2	H2	H2	H2	H2
18 mm	18 mm implants cannot be placed guided						

BLX Implants	RB				WB		
	Ø 3.4 mm	Ø 3.5 mm			Ø 4.5 mm		
							
	BLX Ø 3.5	BLX Ø 3.75	BLX Ø 4.0	BLX Ø 4.5	BLX Ø 5.0	BLX Ø 5.5	BLX Ø 6.5
6 mm							
8 mm							
10 mm							
12 mm							
14 mm		H2/H4	H2/H4	H2/H4	H2/H4	H2/H4	H2/H4
16 mm		H2	H2	H2	H2	H2	H2
18 mm	18 mm implants cannot be placed guided						

* For WT (Ø 6.5 mm) remove the template for freehand profile drilling.

Note: Guided handles are compatible up to Ø 4.2 mm. For drills with Ø 4.7 mm and larger remove the template for freehand drilling.

5. T-SLEEVE POSITION AND IMPLANT LENGTH MATRIX

5.1 T-SLEEVES Ø 5.0 MM

Implant length		6 mm	8 mm	10 mm	12 mm	14 mm	16 mm
Sleeve position	H2 2 mm	Short drill — +3 handle ●●●	Short drill — +1 handle ●	Medium drill = +3 handle ●●●	Medium drill = +1 handle ●	Long drill ≡ +3 handle ●●●	Long drill ≡ +1 handle ●
	H4 4 mm	Short drill — +1 handle ●	Medium drill = +3 handle ●●●	Medium drill = +1 handle ●	Long drill ≡ +3 handle ●●●	Long drill ≡ +1 handle ●	
	H6 6 mm	Medium drill = +3 handle ●●●	Medium drill = +1 handle ●	Long drill ≡ +3 handle ●●●	Long drill ≡ +1 handle ●		

Note: Avoid planning 6 mm and 8 mm Straumann BLC™, TLC™, BLX™ and TLX™ implants in the H2 T-sleeve position, since 4 mm of guided drilling is not possible in the H2 position. Instead, remove the template and continue drilling using conventional procedures.

5.2 CORONAL WIDENING (BLX/TLX)

Implant length		Coronal-widening (4 mm) implant 6-8 mm	Coronal-widening (6 mm) implant 10-18 mm
Sleeve position	H2 2 mm		Short drill — +3 handle ●●●
	H4 4 mm	Short drill — +3 handle ●●●	Short drill — +1 handle ●
	H6 6 mm	Short drill — +1 handle ●	Medium drill = +3 handle ●●●

5.3 T-SLEEVES Ø 2.8 MM (NARROW INTERDENTAL SPACE)

The Ø2.8 mm T-sleeve has a height of 6 mm. This is the equivalent of adding the +1 mm cylinder height to the 5.0 mm T-sleeve height. Hence no drill handles are required.

Implant length		6 mm	8 mm	10 mm	12 mm	14 mm	16 mm
Sleeve position	H2 2 mm		Short drill — No handle		Medium drill = No handle		Long drill ≡ No handle
	H4 4 mm	Short drill — No handle		Medium drill = No handle		Long drill ≡ No handle	
	H6 6 mm		Medium drill = No handle		Long drill ≡ No handle		

5.4 T-SLEEVES Ø 2.2 MM (PILOT GUIDED)

The Ø2.2 mm T-sleeve has a height of 6 mm. This is the equivalent of adding the +1 mm cylinder height to the 5.0 mm T-sleeve height. Hence no drill handles are required.

Implant length		6 mm	8 mm	10 mm	12 mm	14 mm	16 mm
Sleeve position	H2 2 mm		Short drill — No handle		Medium drill = No handle		Long drill ≡ No handle
	H4 4 mm	Short drill — No handle		Medium drill = No handle		Long drill ≡ No handle	
	H6 6 mm		Medium drill = No handle		Long drill ≡ No handle		

5.5 SURGICAL CASSETTE FOR GUIDED SURGERY

The Straumann® Modular Cassette is used for the secure storage and support during surgery with surgical and auxiliary instruments of the Straumann® Dental Implant System. The Straumann® Modular Cassette works with any Straumann® implant line including with the Straumann® Guided Surgery workflow.

The system consists of three modules named A, B and C.



The A Module stores tools that can be shared among different implant lines. Removable trays provide dedicated spaces to store instruments.

The B Module stores tools for a specific implant line. Removable trays are dedicated to an implant line workflow.

The C Module Guided Surgery stores guided handles and instrumentation for template fixation pins. All tools are stored horizontally on the holder.

The B Module features different workflow trays that store cutting tools for specific implant lines. The B Module should be used together with an A Module to complete the tools required for implant surgery.

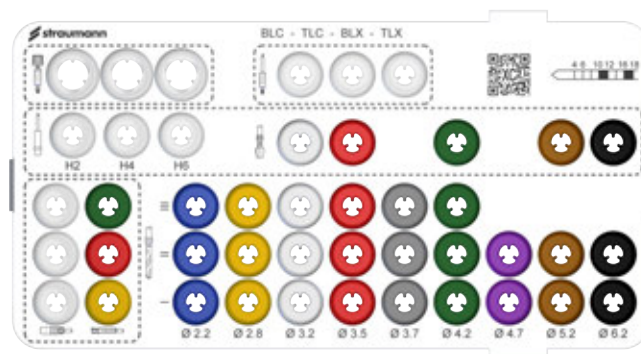

Straumann® B Module TorcFit™ BLC/TLC/BLX/TLX Tray (041.788)

Please refer to Chapter 7. *Article List* on page 31, to the *Straumann® Modular Cassette, Basic Information* (702527/en) and *Straumann® Modular Cassette, Selection Guide* (702824/en) for further instructions.

6. RELATED DOCUMENTS



























For further information, please consult the following brochures:















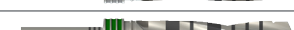







- *Straumann BLX™ Implant System, Basic Information (702115/en)*
- *Straumann TLX™ Implant System, Basic Information (702854/en)*
- *Straumann® Modular Cassette, Basic Information (702527/en)*
- *Straumann® Modular Cassette, Selection Guide (702824/en)*
- *Straumann® Surgical and Prosthetic Instruments, Care and maintenance (702000/en)*
- *Straumann BLC™ Implant System, Basic Information (705651/en)*
- *Straumann TLC™ Implant System, Basic Information (705650/en)*
- *Straumann iEXCEL™ System Surgical Procedures, Basic Information (707743/en)*
- *Straumann iEXCEL™ System Prosthetic Procedures, Basic Information (707744/en)*

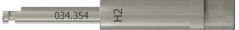

















7. ARTICLE LIST – INSTRUMENTS FOR GUIDED SURGERY

For Surgical Kit set up refer to the *Modular Cassette Selection Guide (702824/en)*.







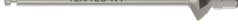



























7.1 GUIDED SURGERY WITH BLC, TLC, BLX AND TLX IMPLANTS







Art. No.	Picture	Article description
B Module		
041.776		Straumann® Modular Cassette, B Module
041.788		BLC/TLC/BLX/TLX Tray, Guided
034.010		Mucosa Punch Ø3.4 mm, 30 mm, guided
034.011		Mucosa Punch Ø4.0 mm, 30 mm, guided
034.012		Mucosa Punch Ø4.7 mm, 30 mm, guided
034.215		Milling Cutter, Ø2.8 mm, 32.5 mm, guided
034.415		Milling Cutter, Ø3.5 mm, 32.5 mm, guided
034.615		Milling Cutter, Ø4.2 mm, 32.5 mm, guided
066.1301		Pilot VeloDrill™, guided, Ø2.2 mm, short
066.1302		VeloDrill™, guided, Ø2.8 mm, short, stainless steel
066.1303		VeloDrill™, guided, Ø3.2 mm, short, stainless steel
066.1304		VeloDrill™, guided, Ø3.5 mm, short, stainless steel
066.1305		VeloDrill™, guided, Ø3.7 mm, short, stainless steel
066.1306		VeloDrill™, guided, Ø4.2 mm, short, stainless steel
066.1307		VeloDrill™, guided, Ø4.7 mm, short, stainless steel
066.1308		VeloDrill™, guided, Ø5.2 mm, short, stainless steel
066.1309		VeloDrill™, guided, Ø6.2 mm, short, stainless steel
066.1501		Pilot VeloDrill™, guided, Ø2.2 mm, medium, stainless steel
066.1502		VeloDrill™, guided, Ø2.8 mm, medium, stainless steel
066.1503		VeloDrill™, guided, Ø3.2 mm, medium, stainless steel
066.1504		VeloDrill™, guided, Ø3.5 mm, medium, stainless steel
066.1505		VeloDrill™, guided, Ø3.7 mm, medium, stainless steel
066.1506		VeloDrill™, guided, Ø4.2 mm, medium, stainless steel
066.1507		VeloDrill™, guided, Ø4.7 mm, medium, stainless steel
066.1508		VeloDrill™, guided, Ø5.2 mm, medium, stainless steel
066.1509		VeloDrill™, guided, Ø6.2 mm, medium, stainless steel

Art. No.	Picture	Article description
B Module		
066.1701		Pilot VeloDrill™, guided, Ø2.2 mm, long, stainless steel
066.1702		VeloDrill™, guided, Ø2.8 mm, long, stainless steel
066.1703		VeloDrill™, guided, Ø3.2 mm, long, stainless steel
066.1704		VeloDrill™, guided, Ø3.5 mm, long, stainless steel
066.1705		VeloDrill™, guided, Ø3.7 mm, long, stainless steel
066.1706		VeloDrill™, guided, Ø4.2 mm, long, stainless steel
066.1707		VeloDrill™, guided, Ø4.7 mm, long, stainless steel
034.362		BLC/TLC Profile Drill, short, FIBA compatible, Ø3.3 mm, L 27 mm, stainless steel
034.363		BLC/TLC Profile Drill, short, FIBA compatible, Ø3.75 mm, L 26 mm, stainless steel
034.364		BLC Profile Drill, short, FIBA compatible, Ø4.0 mm, L 26 mm, stainless steel
034.365		BLC/TLC Profile Drill, short, FIBA compatible, Ø4.5 mm, L 26 mm, stainless steel
034.382		BLC Profile Drill, short, Ø5.0 mm, L 26 mm, stainless steel
034.366		BLC/TLC Profile Drill, short, Ø5.5 mm, L 26 mm, stainless steel
034.367		BLC/TLC Profile Drill, short, Ø6.5 mm, L 26 mm, stainless steel
034.354		Guided Adapter for Profile Drill, FIBA, H2, handpiece, stainless steel
034.355		Guided Adapter for Profile Drill, FIBA, H4, handpiece, stainless steel
034.356		Guided Adapter for Profile Drill, FIBA, H6, handpiece, stainless steel
066.4403		TorcFit™ BLC, BLX Guided Implant Driver, for handpiece, stainless steel
066.4404		TorcFit™ BLC, BLX Guided Implant Driver, for ratchet, stainless steel
037.3000		TorcFit™ TLC, TLX Guided Implant Driver, for ratchet, for TLC/TLX S, stainless steel
037.3001		TorcFit™ TLC, TLX Guided Implant Driver, for handpiece, for TLC/TLX S, stainless steel
037.3002		TorcFit™ TLC, TLX Guided Implant Driver, for ratchet, for TLC/TLX SP, stainless steel
037.3003		TorcFit™ TLC, TLX Guided Implant Driver, for handpiece, for TLC/TLX SP, stainless steel
066.4401		BLC, BLX Guided Implant Driver, ratchet, screw-retained

Art. No.	Picture	Article
C Module		
041.772		Straumann® ModularCassette, C Module, Guided Surgery
026.0147		Drill Handle, Ø2.2 mm, 1 mm/3 mm stop, stainless steel
026.0148		Drill Handle, Ø2.8 mm, 1 mm/3 mm stop, stainless steel
026.0149		Drill Handle, Ø3.2 mm, 1 mm/3 mm stop, stainless steel
026.0150		Drill Handle, Ø3.5 mm, 1 mm/3 mm stop, stainless steel
026.0151		Drill Handle, Ø3.7 mm, 1 mm/3 mm stop, stainless steel
026.0152		Drill Handle, Ø4.2 mm, 1 mm/3 mm stop, stainless steel
034.284		Drill for Template Fixation Pin, Ø1.3 mm
034.282		Template Fixation Pin, Ø1.3 mm
034.298		Template Fixation Pin, Ø2.8/2.8 mm, guided
034.285		Template Fixation Pin, Ø5/2.8 mm, guided, stainless steel
034.286		Template Fixation Pin, Ø5/3.2 mm, guided, stainless steel
034.287		Template Fixation Pin, Ø5/3.5 mm, guided, stainless steel
034.288		Template Fixation Pin, Ø5/3.7 mm guided, stainless steel
034.289		Template Fixation Pin, Ø5/4.2 mm, guided, stainless steel
036.3300		RT Profile Drill, short, for implants Ø3.75/Ø4.8 mm, stainless steel (TLC/TLX only)
036.3301		RT Profile Drill, long, for implants Ø3.75/Ø4.8 mm, stainless steel (TLC/TLX only)
036.3302		WT Profile Drill, short, for implants Ø5.5/Ø6.5 mm, stainless steel (TLC/TLX only)
036.3303		WT Profile Drill, long, for implants Ø5.5/Ø6.5 mm, stainless steel (TLC/TLX only)

7.2 GUIDED SURGERY WITH BLC, TLC, BLX AND TLX IMPLANTS (SINGLE USE)

Art. No.	Picture	Article
066.11015		Pilot VeloDrill™, Ø 2.2 mm, extra short, single use, TAN
066.13015		Pilot VeloDrill™, Ø 2.2 mm, short, single use, TAN
066.15015		Pilot VeloDrill™, Ø 2.2 mm, medium, single use, TAN
066.17015		Pilot VeloDrill™, Ø 2.2 mm, long, single use, TAN
066.11025		VeloDrill™, Ø 2.8 mm, extra short, single use, TAN
066.13025		VeloDrill™, Ø 2.8 mm, short, single use, TAN
066.15025		VeloDrill™, Ø 2.8 mm, medium, single use, TAN
066.17025		VeloDrill™, Ø 2.8 mm, long, single use, TAN
066.11035		VeloDrill™, Ø 3.2 mm, extra short, single use, TAN
066.13035		VeloDrill™, Ø 3.2 mm, short, single use, TAN
066.15035		VeloDrill™, Ø 3.2 mm, medium, single use, TAN
066.17035		VeloDrill™, Ø 3.2 mm, long, single use, TAN
066.11045		VeloDrill™, Ø 3.5 mm, extra short, single use, TAN
066.13045		VeloDrill™, Ø 3.5 mm, short, single use, TAN
066.15045		VeloDrill™, Ø 3.5 mm, medium, single use, TAN
066.17045		VeloDrill™, Ø 3.5 mm, long, single use, TAN
066.11055		VeloDrill™, Ø 3.7 mm, extra short, single use, TAN
066.13055		VeloDrill™, Ø 3.7 mm, short, single use, TAN
066.15055		VeloDrill™, Ø 3.7 mm, medium, single use, TAN
066.17055		VeloDrill™, Ø 3.7 mm, long, single use, TAN
066.11065		VeloDrill™, Ø 4.2 mm, extra short, single use, TAN
066.13065		VeloDrill™, Ø 4.2 mm, short, single use, TAN
066.15065		VeloDrill™, Ø 4.2 mm, medium, single use, TAN
066.17065		VeloDrill™, Ø 4.2 mm, long, single use, TAN
066.11075		VeloDrill™, Ø 4.7 mm, extra short, single use, TAN
066.13075		VeloDrill™, Ø 4.7 mm, short, single use, TAN
066.15075		VeloDrill™, Ø 4.7 mm, medium, single use, TAN
066.17075		VeloDrill™, Ø 4.7 mm, long, single use, TAN
066.11085		VeloDrill™, Ø 5.2 mm, extra short, single use, TAN
066.13085		VeloDrill™, Ø 5.2 mm, short, single use, TAN
066.15085		VeloDrill™, Ø 5.2 mm, medium, single use, TAN
066.11095		VeloDrill™, Ø 6.2 mm, extra short, single use, TAN
066.13095		VeloDrill™, Ø 6.2 mm, short, single use, TAN
066.15095		VeloDrill™, Ø 6.2 mm, medium, single use, TAN

Art. No.	Picture	Article
034.362S		BLC/TLC Profile Drill, short, FIBA compatible, Ø 3.3 mm, L 27 mm, single use, TAN
034.363S		BLC/TLC Profile Drill, short, FIBA compatible, Ø 3.75 mm, L 26 mm, single use, TAN
034.364S		BLC Profile Drill, FIBA compatible, Ø 4.0 mm, L 26 mm, single use, TAN
034.365S		BLC/TLC Profile Drill, short, FIBA compatible, Ø 4.5 mm, L 26 mm, single use, TAN
034.382S		BLC Profile Drill, Ø 5.0 mm, L 26 mm, single use, TAN
034.366S		BLC/TLC Profile Drill, short, Ø 5.5 mm, L 26 mm, single use, TAN
034.367S		BLC/TLC Profile Drill, short, Ø 6.5 mm, L 26 mm, single use, TAN

International Headquarters

Institut Straumann AG

Peter Merian-Weg 12

CH-4002 Basel, Switzerland

Phone +41 (0)61 965 11 11

Fax +41 (0)61 965 11 01

www.straumann.com

© Institut Straumann AG, 2026. All rights reserved.

Straumann® and/or other trademarks and logos from Straumann® mentioned herein are the trademarks or registered trademarks of Straumann Holding AG and/or its affiliates.

