

# BASIC INFORMATION

Straumann® Guided Surgery  
System Instruments

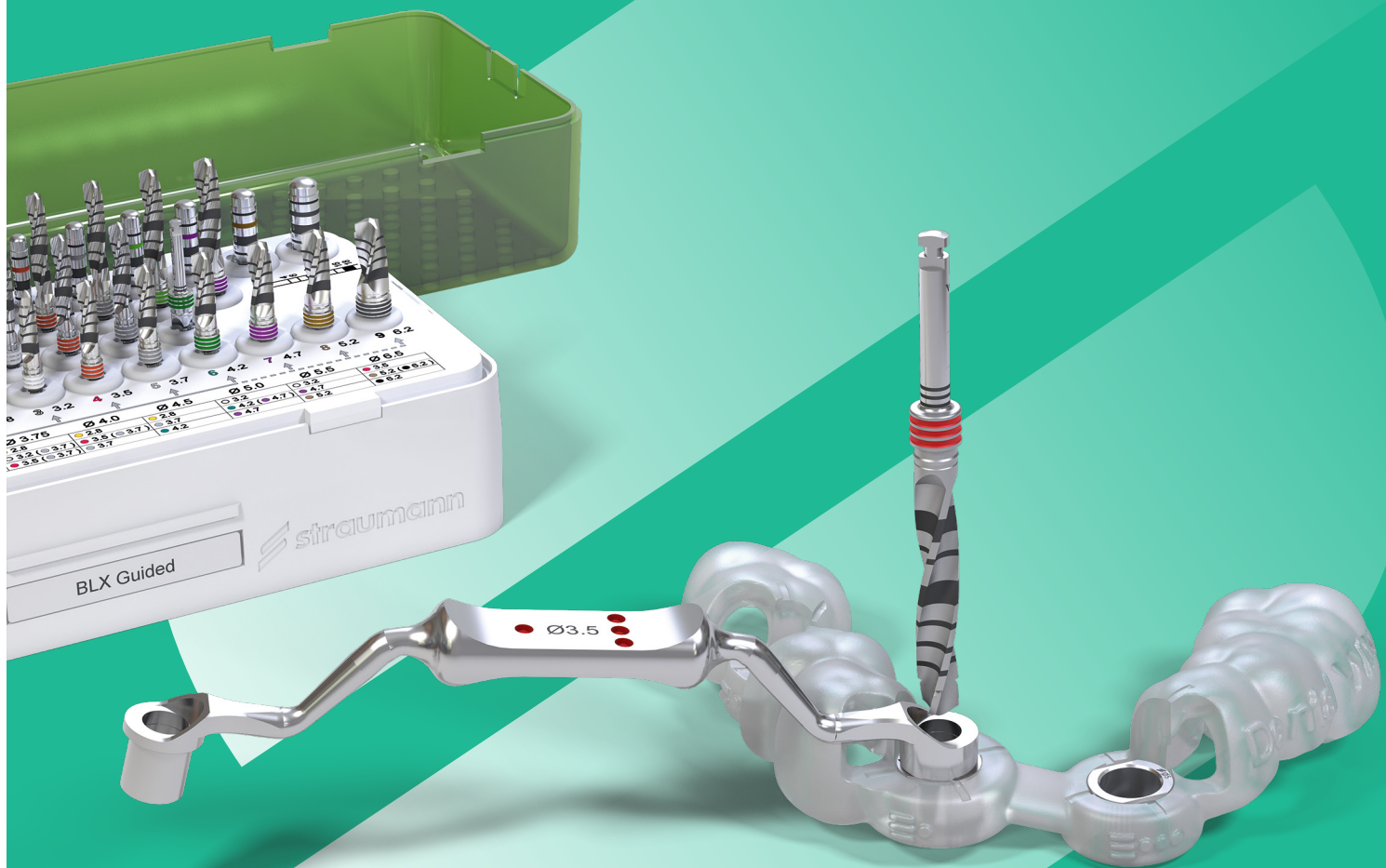

*Technical handling information*

## **ABOUT THIS GUIDE**

This guide provides an overview of the instruments required for the Straumann® Guided Surgery Workflow and describes the steps required for guided implant bed preparation and guided placement of implants of the Straumann® Dental Implant system. It is assumed that the user is familiar with placing dental implants. Not all detailed information will be found in this guide. Reference to existing Straumann® procedure manuals will be made throughout this document.

Not all products shown are available in all markets.

# CONTENTS

<b>1. THE STRAUMANN® GUIDED SURGERY INSTRUMENTS</b>	<b>3</b>
1.1 Overview of the Straumann® Guided Surgery instruments	3
1.2 Implant bed depth control	4
1.3 coDiagnostiX® surgical protocol	5
1.4 Surgical Cassette for Guided Surgery	7
<b>2. SURGICAL PROCEDURE</b>	<b>8</b>
2.1 Site preparation	9
2.2 Basic implant bed preparation	10
2.3 Fine implant bed preparation	12
2.4 Guided implant insertion	13
<b>3. TECHNICAL INFORMATION ON STRAUMANN® GUIDED INSTRUMENTS</b>	<b>16</b>
3.1 Surgical Template and guided instruments	16
3.2 Cutting instruments	22
3.3 Guided implant placement	29
<b>4. STRAUMANN® DENTAL IMPLANT PORTFOLIO FOR GUIDED SURGERY</b>	<b>32</b>
<b>5. T-SLEEVE POSITION AND IMPLANT LENGTH MATRIX</b>	<b>34</b>
5.1 T-sleeves Ø 5.0 mm	34
5.2 Coronal widening	34
5.3 T-sleeves Ø 2.8 mm (narrow interdental space)	35
5.4 T-sleeves Ø 2.2 mm (pilot guided)	35
<b>6. RELATED DOCUMENTS</b>	<b>36</b>
<b>7. ARTICLE LIST – INSTRUMENTS FOR GUIDED SURGERY</b>	<b>37</b>
7.1 Guided Surgery with Tissue Level Implants (TL S/TL SP)	37
7.2 Guided Surgery with Bone Level Implants (BL)	39
7.3 Guided Surgery with Bone Level Tapered Implants (BLT)	41
7.4 Guided Surgery with BLX and TLX Implants	43



# 1. THE STRAUMANN® GUIDED SURGERY INSTRUMENTS

The Straumann® Guided Surgery instruments are used for guided implant bed preparation and guided placement of dental implants of the Straumann® Dental Implant System.

Cutting instruments for the site and implant bed preparation can be used guided either directly through the Ø5.0mm T-Sleeve of the Surgical Template (Mucosa Punch), through a Guided Drill Handle (Milling Cutter and Drills) or in conjunction with a Guided Adapter (Profile Drills and Taps).

Straumann® implants with a Loxim® Transfer piece can be placed guided with the help of a Guided Adapter, for TorcFit™ Implant a Guided Implant driver can be used.

## 1.1 OVERVIEW OF THE STRAUMANN® GUIDED SURGERY INSTRUMENTS

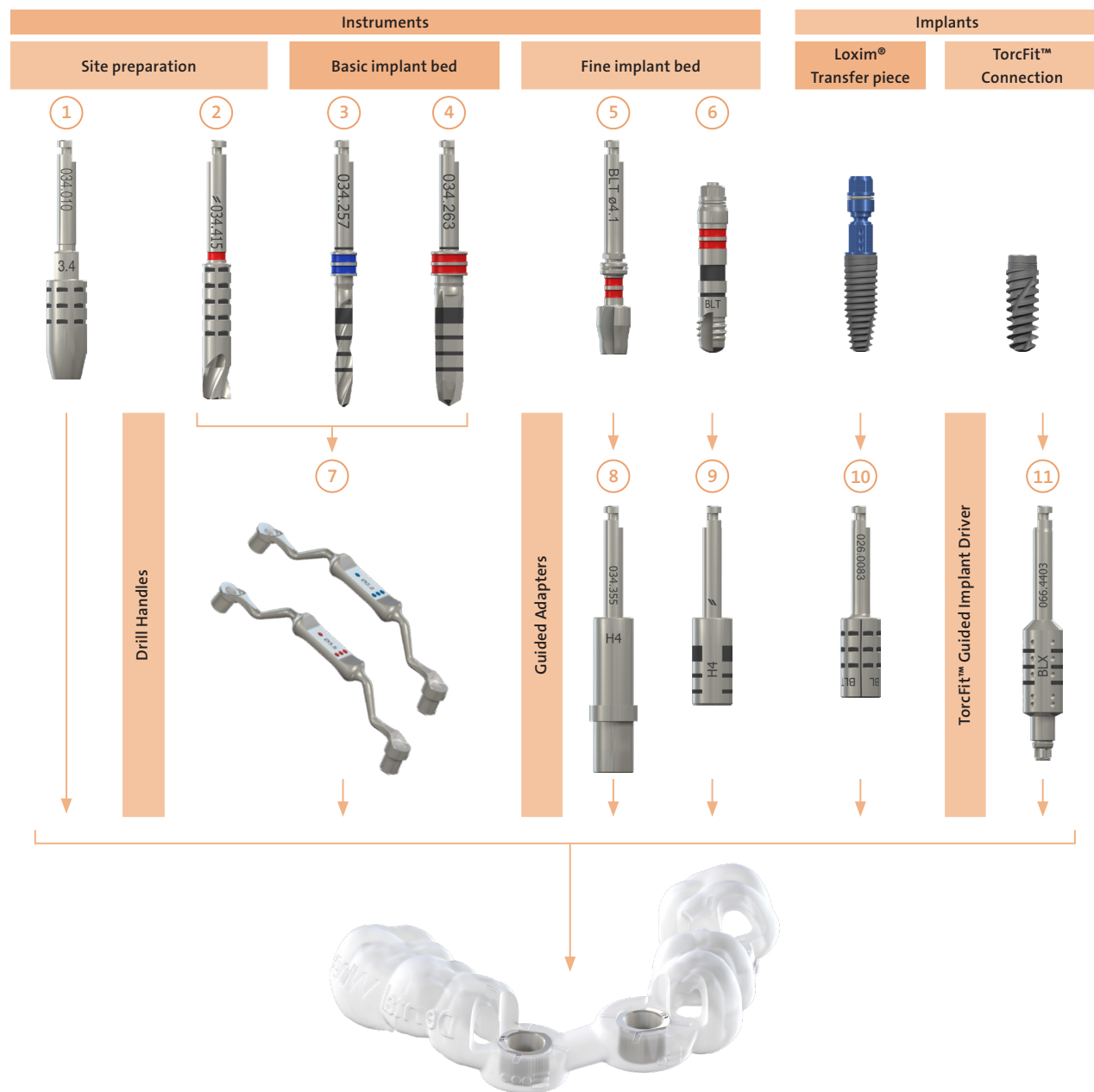

### Cutting instruments:

- Mucosa Punch (see page 22)
- Milling Cutter (see page 23)
- Pilot Twist Drill PRO Ø2.2 mm (see page 24)
- Drills Ø2.8-4.2 mm (see page 24)
- Profile Drill – FIBA compatible (see page 27)
- Tap – FIBA compatible (see page 28)

### Guiding instruments:

- Drill Handles with Guiding Cylinders (see page 20)
- Guided Adapter for Profile Drill, FIBA (see page 21)
- Guided Adapter for Tap, FIBA (see page 21)
- Guided Adapter for the Loxim® Transfer Piece (See page 29)
- TorcFit™ Guided Implant Driver (BLX/TLX) (see page 30)
- Surgical Template with Ø5 mm metal Sleeve (see page 17)

## 1.2 IMPLANT BED DEPTH CONTROL

Any desired implant bed depth between 4 mm and 16 mm can be achieved by selecting a specific combination of the T-sleeve position, the Drill Handle cylinder height and the drill lengths.

### Flexible T-sleeve position

The T-sleeve can be positioned at 3 different heights, indicated as H2, H4 and H6. The indicated height represents the distance between the T-sleeve and planned final implant position (implant shoulder).

T-sleeve positioning can be determined by the following criteria:

- Mucosal thickness,
- Type of Surgical Template (mucosa, bone or tooth-supported)
- Access for instrument irrigation.

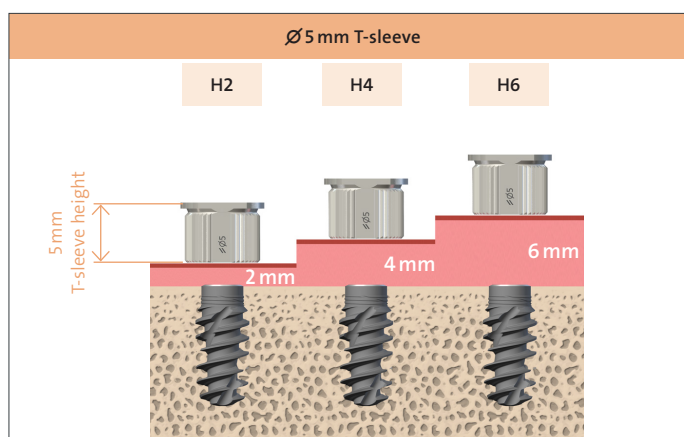

**Note:** For maximum precision, always select the lowest T-sleeve position possible; T-sleeve contact with tissue must be avoided.

### Two different cylinder heights

Straumann® Guided Surgery Drill Handles have two different cylinder heights (1 mm and 3 mm) marked on the instrument with colored dots.

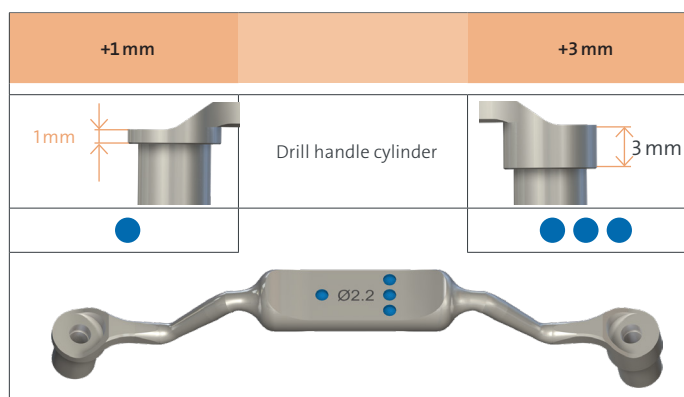

### Three different drill lengths

Straumann® Guided Surgery Drills are available in 3 different lengths (short, medium and long). The drill length is indicated on the drill shaft by a laser mark.

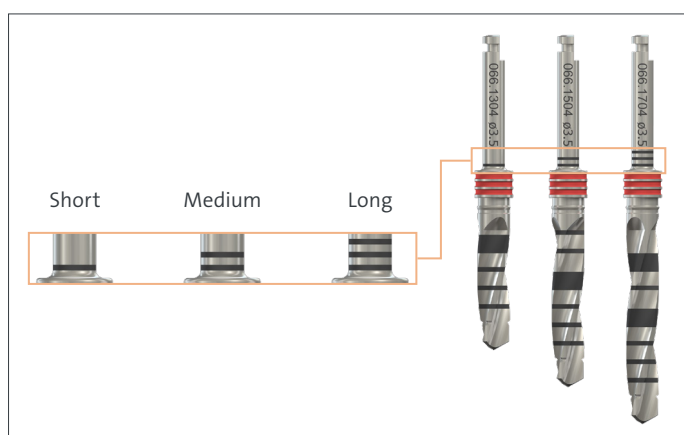

## 1.3 CODIAGNOSTIX® SURGICAL PROTOCOL

coDiagnostiX®, the planing and guide design software from Dental Wings GmbH, Chemnitz (Germany), calculates the surgical protocol based on the virtual planning of implant placement and choice of T-sleeve type and position. The surgical protocol recommends which Drill Handle cylinder (+1 mm or +3 mm) and which drill lengths (short, medium, or long) are required for preparing the osteotomy for each specific implant. Two different types of surgical protocols are provided by coDiagnostiX®: one for the classic Straumann® Dental Implant Systems including Tissue Level Implants, Bone Level Implants and Bone Level Tapered Implants, and the other for Straumann® BLX and TLX Implant systems, using Straumann® Velodrills™.

### 1.3.1 Straumann® Tissue Level Implants, Bone Level Implants and Bone Level Tapered Implants

Straumann® BLT implants		Surgical protocol							FDI notation (World Dental Federation)	
Straumann® Guided Surgery Sleeve										
Position	Milling Cutter	Pilot Drill	Guided Drill	Guided Drill	Guided Drill	Profile Drill	Tap	Implant	Depth Stop	
42	Ø 4.2 ●	Ø 2.2 BLT ● ■	Ø 2.8 BLT D1-D4 ● ■	Ø 3.5 BLT D1-D4 ● ■	Ø 4.2 BLT D1-D3 or dense cortex only ● ■	Ø 4.8 BLT D1-D2 or dense cortex only H2 ● ■	Ø 4.8 BLT D1 H2 ● ■	021.7316 BLT RC Ø 4.8 16 mm SLActive®	H2	

Above is an example of a surgical protocol for a Straumann® BLT Ø 4.8/16 mm on tooth position 42, with a selected T-sleeve position of H2. The recommended drills (Ø and color code) and the required combination of cylinder height (dots) and drill length (lines) are indicated in the table. The applicability per bone class is indicated with D1 to D4 for each step.

### 1.3.2 Straumann® BLX and TLX Implants

Straumann® BLX implants		Surgical protocol										FDI notation (World Dental Federation)	
Straumann® VeloDrill™ Guided Surgery													
Position	Milling Cutter	Ø2.2 X VeloDrill™	Bone density	Ø2.8 X VeloDrill™	Ø3.2 X VeloDrill™	Ø3.5 X VeloDrill™	Ø3.7 X VeloDrill™	Ø4.2 X VeloDrill™	Ø4.7 X VeloDrill™	Ø5.2 X VeloDrill™	Ø6.2 X VeloDrill™	Implant	Depth Stop
32	Ø 3.5 ●	● ■	soft/D4 medium/D2-D3 hard/D1	● ■		● ■	● ■ ● ■					061.5312 BLX RB Ø 4 12 mm SLActive®	H6

Above is an example of a surgical protocol for a Straumann® BLX Ø 4.0/12 mm on tooth position 32, with a selected T-sleeve position at H6. The recommended drills (Ø and color code) and the required combination of cylinder height (dots) and drill length (lines) are indicated in the table. A “c” in the dots means that this drill step should be used for coronal widening only (see *Widen coronal bone* on page 11).

The example on the next page can be used to calculate manually the required combination of Drill Handle cylinder height and implant length in case of an intraoperative change of the implant length.

For more information please refer to <https://www.codiagnostix.com>.

**Example of how to achieve an implant bed depth for a 10 mm implant**

For guided implant bed preparation using a 10 mm Straumann® Implant, T-sleeve position H2 and H6 can be used. The following examples show how the different components of the Straumann® Guided Surgery System fit together to achieve a 10 mm implant bed depth.

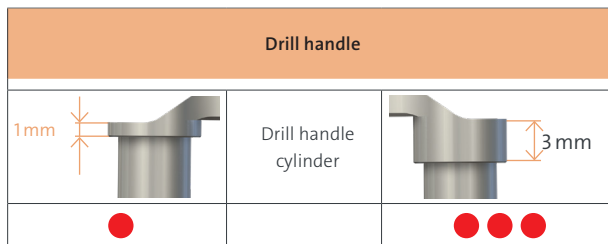
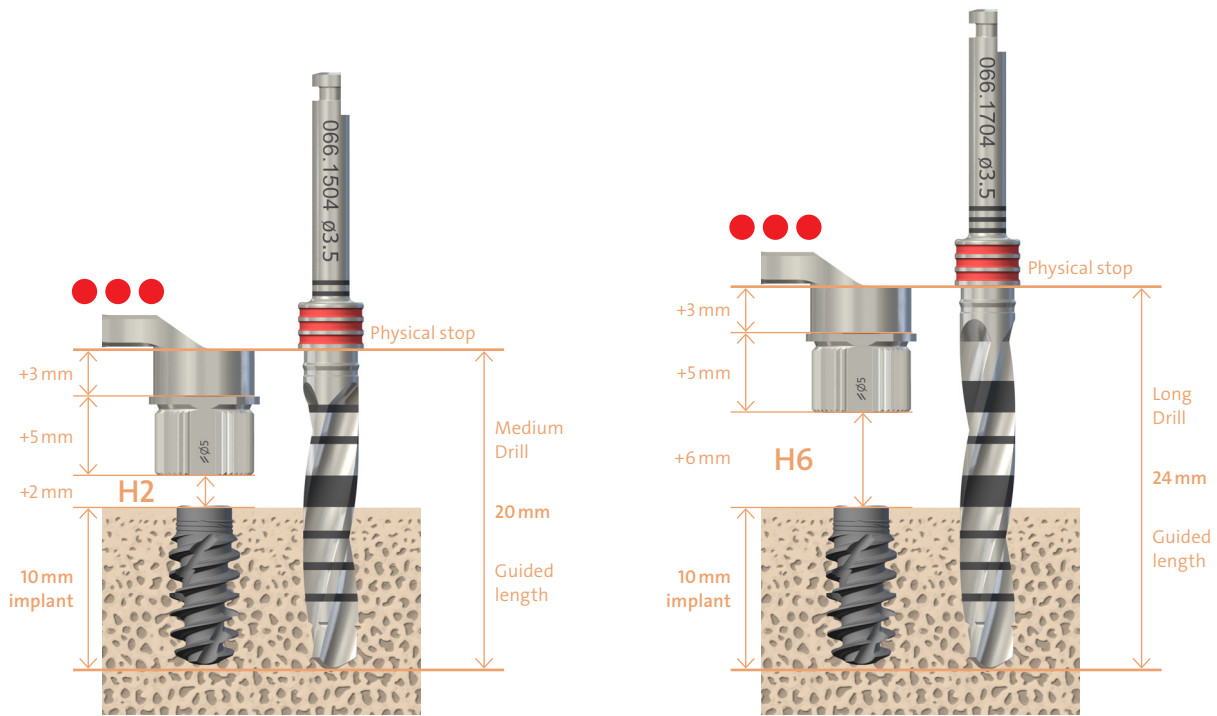

Drill name	Guided length	Overall length	Symbol for drill length
Short	16 mm	34 mm	—
Medium	20 mm	38 mm	≡
Long	24 mm	42 mm	≡≡

For more information please refer to Chapter 5. *T-sleeve position/implant length matrix* on page 34.

## 1.4 SURGICAL CASSETTE FOR GUIDED SURGERY

The Straumann® Modular Cassette is used for the secure storage and reprocessing of surgical and auxiliary instruments of the Straumann® Dental Implant System. The Straumann® Modular Cassette works with any Straumann® implant line (e.g. SP, BLT, BLX), including with the Straumann® Guided Surgery workflow.

The system consists of three modules named A, B and C.



The A Module stores tools that can be shared among different implant lines. Removable trays provide dedicated spaces to store instruments.



The B Module stores tools for a specific implant line. Removable trays are dedicated to an implant line workflow.



The C Module Guided Surgery stores guided handles and instrumentation for template fixation pins. All tools are stored horizontally on the holder.

The B Module features different workflow trays that store cutting tools for specific implant lines. The B Module should be used together with an A Module to complete the tools required for implant surgery.

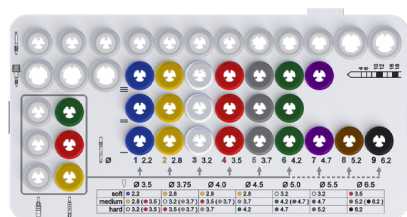

Straumann® BLX/TLX T  
Guided Fully Tapered Tray

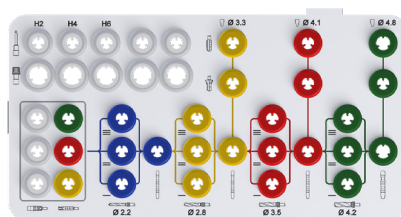

Straumann® BLT  
Guided Basic Tray



Straumann® BL/TL  
Guided Parallel Walled Tray

Please refer to Chapter 7. *Article List* on page 37, to the *Straumann® Modular Cassette, Basic Information (702527/en)* and *Straumann® Modular Cassette, Selection Guide (702824/en)* for further instructions.

### Note:

The conventional, non-modular Straumann® Guided Surgery Cassette (Art. No. 034.001) and the Straumann® Basic Guided Surgery Cassette (Art. no. 034.281) don't provide the adequate storage space and workflow for the new Straumann® Guided Surgery components, like the Guided Adapters FIBA, the FIBA compatible Profile Drills and Taps and the new short Drill Handles.

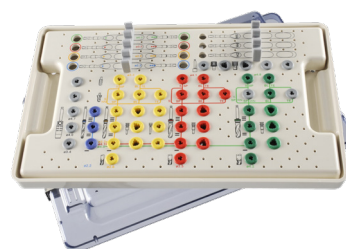

## 2. SURGICAL PROCEDURE

After receiving the Surgical Template from the manufacturer and prior to starting any surgical procedure, evaluate the fit and stability on the model and in the patient's mouth as well as the size and location of the openings for irrigation. Verify that the position and orientation of the T-sleeves in the Surgical Template match the preoperative plan and surgical protocol and also verify that the right Drill Handles to fit into the selected T-sleeves are available (round or self-locking).

For more information please refer to Chapter 3. *Technical information on Straumann® guided instruments* on page 16.

The Straumann® Guided Surgery workflow offers guided pilot drilling or fully guided surgery which included guided implant bed preparation and guided implant placement.

### Guided pilot drilling

For guided pilot drilling, only the  $\varnothing 2.2$  mm pilot drill is needed. The dedicated “ $\varnothing 2.2$  mm T-sleeves for guided pilot drilling” allow the use of the drill without drill handles.

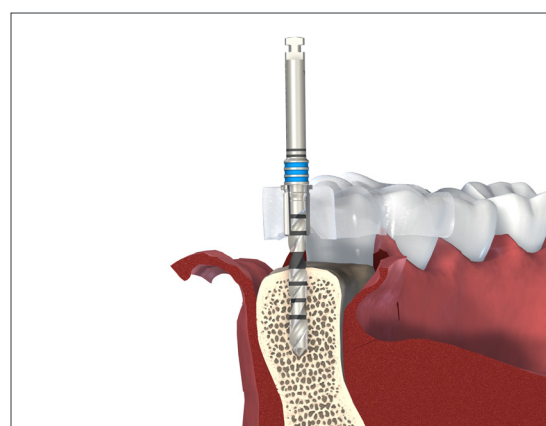

### Fully guided surgery

The Straumann®  $\varnothing 5.0$  mm T-sleeve is used for fully guided drilling and implant placement, suiting implant diameters of between  $\varnothing 3.3$  mm and  $\varnothing 4.8$  mm, it is also compatible with the Straumann® Guided Surgery Drill Handles, the Guided Adapters and the Guided Implant Drivers

For implants wider than  $\varnothing 4.8$  mm, the implant bed can be pre-drilled up to  $\varnothing 4.2$  mm, and then the sequence can be finished free-hand.

A  $\varnothing 2.8$  mm T-sleeve is also available for narrow interdental spaces, which allows guided drilling with the  $\varnothing 2.8$  mm drills without the use of a Drill Handle.

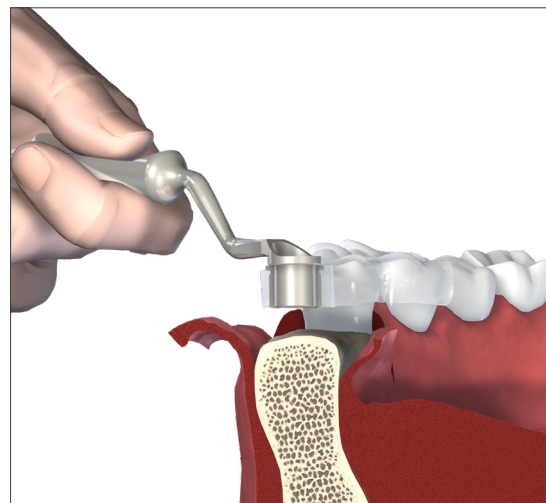

The Surgical Template can be bone, mucosa or tooth-supported, depending on the clinician's preferences and the planning system used. A variety of fixation pins are available for additional stabilization of the Surgical Template. Refer to Chapter 3.1 *Surgical Template and guided instruments* on page 16 for detailed instructions.

## 2.1 SITE PREPARATION

### Mucosa Punch for flapless surgery

The Mucosa Punch can be used through the  $\varnothing 5.0$  mm T-sleeves to punch through the gingiva for surgical access.

The three depth marks indicate the distance from bone level to the top of the rim of the respective T-sleeve (H2, H4, H6).

For more information please refer to Chapter 3.2.1 *Mucosa Punch* on page 22.

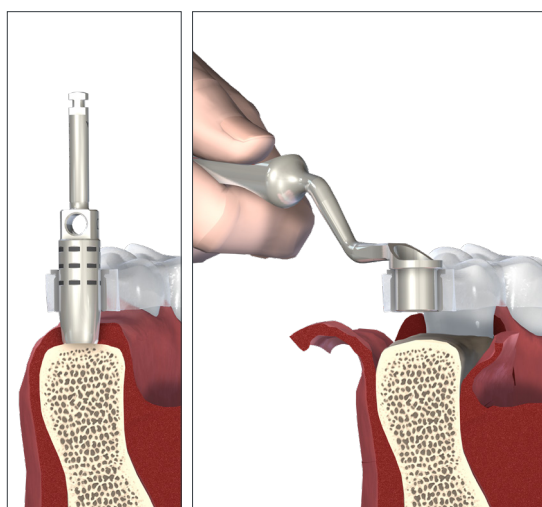

### Flattening the alveolar ridge

The Milling Cutter can be used to create a flat bone surface. Choose the Milling Cutter and corresponding Drill Handle as indicated in the surgical protocol.

Use the laser markings set at 2 mm intervals on the Milling Cutter for depth reference.

**Note:** Milling Cutters have no physical stop. Milling Cutters may only be used for flattening the alveolar ridge.

For more information please refer to Chapter 3.2.2 *Milling Cutter* on page 23.

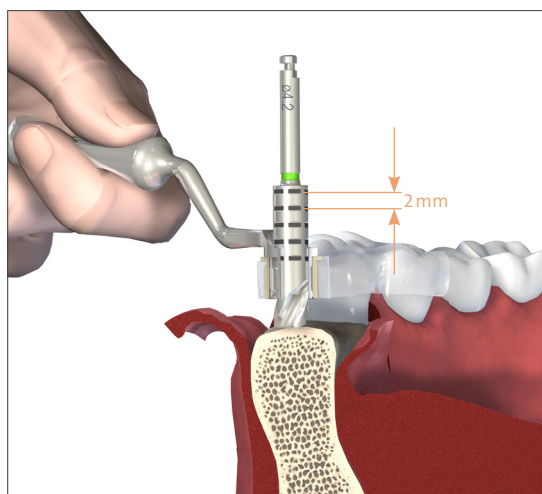

## 2.2 BASIC IMPLANT BED PREPARATION

For the basic implant bed preparation Straumann® guided drills are used in combination with Drill Handles to achieve the desired implant bed depth.

Always make sure to use the correct Drill Handle cylinder (+1 mm (one dot) or +3 mm (3 dots)) and the corresponding drill length (short, medium, or long) as indicated in the surgical protocol.

Start drilling only after fully inserting the drill into the cylinder of the Drill Handles.

### Pilot drilling

Pre-drill the implant bed at no more than 800 rpm with the  $\varnothing$ 2.2 mm Pilot Twist Drill PRO using the corresponding Drill Handle (blue) for guidance. Drill until the physical stop of the guide drill reaches the Drill Handle cylinder to achieve the required osteotomy depth.

Before continuing with the implant bed preparation, determine the bone class at the implant bed site with the appropriate method.

Subsequently, follow the surgical protocol to complete the basic implant bed preparation. For further information on the surgical procedure of the Straumann® Dental Implant System, please refer to the respective Basic Information (See Chapter 6. *Related documents*)

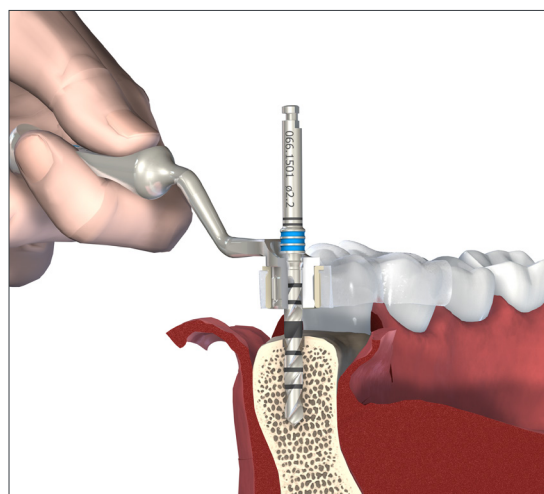

Vertical Template Fixation Pins can then be used for further stabilization of the Surgical Template (see Chapter 3.1.3 *Vertical Template fixation Pins* on page 18).

**Note:** The widest handle is compatible with the  $\varnothing$ 4.2 mm guided drill. For cases that require wider drills ( $\varnothing$ 4.7, 5.2, or 6.2 mm), pre-drill guided to  $\varnothing$ 4.2 mm, remove the template and follow the conventional workflow.

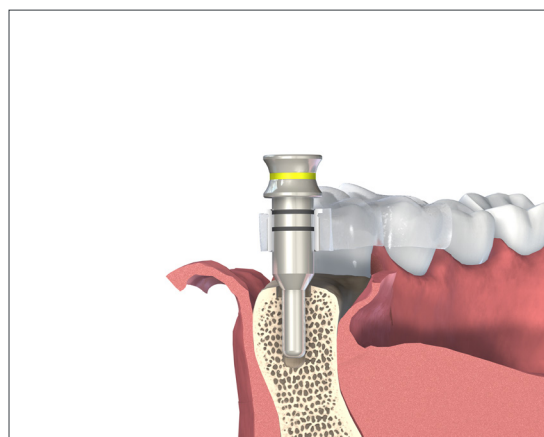

**Widen coronal bone (for BLX and TLX implants only)**

For Straumann® BLX and TLX implants, the coronal segment of medium and hard bone should be widened before implant placement, if indicated by the protocol. The drill size in brackets or marked with a "c" is used for depths of 4 mm (for implant lengths of 6 mm and 8 mm) and 6 mm (for implant lengths of 10 mm and longer) for widening the coronal segment of the implant bed.

**Note:** Avoid planning BLX and TLX implant with a length of 6 mm and 8 mm in the T-sleeve position H2, since 4 mm of guided drilling is not possible in the H2 position. If cortical widening is needed in a site with a T-sleeve in H2 position, remove the template and perform the coronal drilling using conventional procedures.

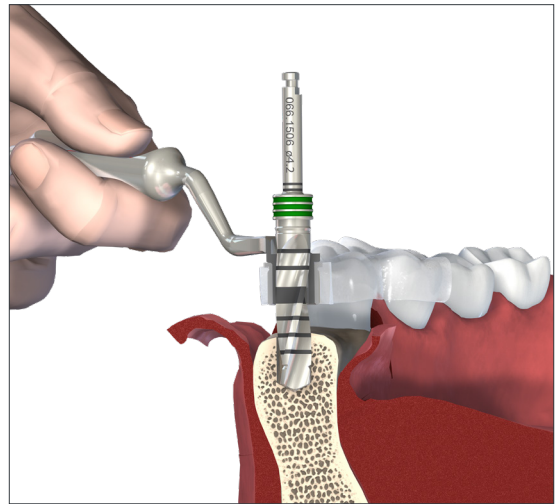

**Caution:**

- Inspect the instruments for operational reliability prior to each surgery and replace if necessary. Avoid lateral pressure on instruments that may damage the instruments themselves, the handle cylinder or the T-sleeve.
- Cutting instruments must not rotate during insertion into, or removal from, T-sleeves or handles.
- Use intermittent drilling with ample cooling of cutting instruments using pre-cooled sterile physiological saline solution.

## 2.3 FINE IMPLANT BED PREPARATION

Fine implant bed preparation includes profile drilling and subsequent tapping. The procedure depends on implant type, endosteal implant diameter and bone class. Fine implant bed preparation is not needed for BLX and TLX implants.

### 2.3.1 Profile drilling

Profile drilling prepares the implant bed for the shape of a specific Straumann® implant. Choose the correct Guided Adapter for profile drill (FIBA-Fine Implant Bed Adapters) according to the T-sleeve position.

Insert the assembled Adapter and profile drill into the  $\varnothing 5.0$  mm T-sleeve. Shape the coronal part of the implant bed with the corresponding guided profile drill and the recommended speed of 300 rpm.

Always drill until the **physical stop** of the Adapter hits the T-sleeve to reach the required depth.

For more information please refer to Chapter 3.1.6 *Guided Adapter for profile drills* on page 21 and Chapter 3.2.4 *Profile Drills, FIBA compatible* on page 27.

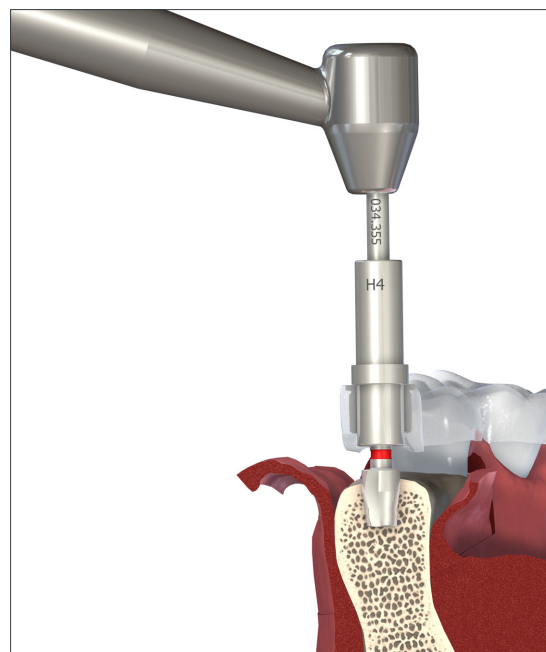

### 2.3.2 Tapping

Tapping prepares the implant bed for a specific thread type. This optional step gives the surgeon the flexibility to adapt the surgical protocol to the bone class to achieve optimal primary implant stability.

Choose the correct Guided Adapter for tap (FIBA) according to T-sleeve position. Insert the assembled Adapter and tap into the  $\varnothing 5.0$  mm T-sleeve.

Tap the implant bed according to bone class and endosteal diameter. Use the laser marks on the guided taps for visual depth reference. The maximum recommended speed is 15 rpm.

**Caution:** Do not apply torque greater than 60 Ncm. Torque values above 60 Ncm may damage the tap.

For manual profile drilling and tapping with a Ratchet use the Connector for Ratchet, art. no. 034.005.

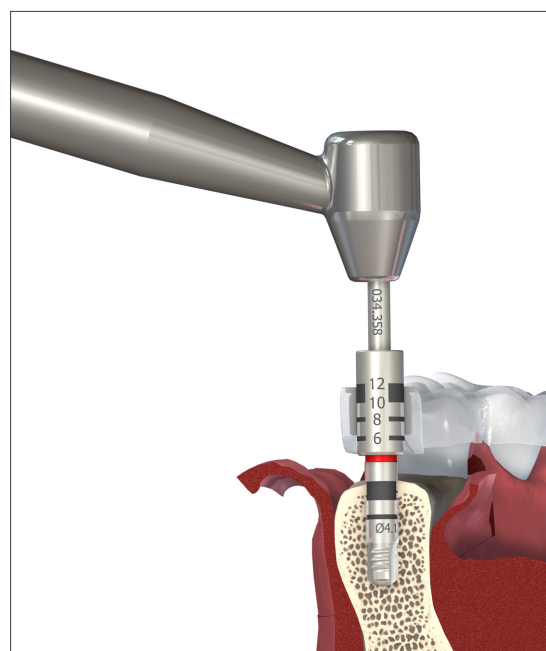

For instruction on the old guided Profil Drills and guided Taps, compatible with the C-Handles, please refer to the document *Straumann® Guided Surgery Basic Information (702083)*.

## 2.4 GUIDED IMPLANT INSERTION

Guided implant placement can be used to maximize precision. The implant can be inserted through Straumann® Ø5.0 mm T-sleeves using either visual depth control or physical depth control with the Stop Key.

Alternatively, remove the Surgical Template and place the implant using the conventional procedure without Surgical Templates as described on the surgical procedure of the Straumann® Dental Implant System, please refer to the respective Basic Information (See Chapter 6. *Related documents*).

For Straumann® implants using a Loxim® Transfer Piece, the Straumann® Guided Adapter is used for inserting implants through Straumann® Ø5.0 mm T-sleeve using visual depth control.

For Straumann® implants with the TorcFit™ connection (e.g. BLX, TLX), a Guided Implant Driver is used for inserting implants through the T-sleeve using either visual depth control or physical depth control with the Stop Key.

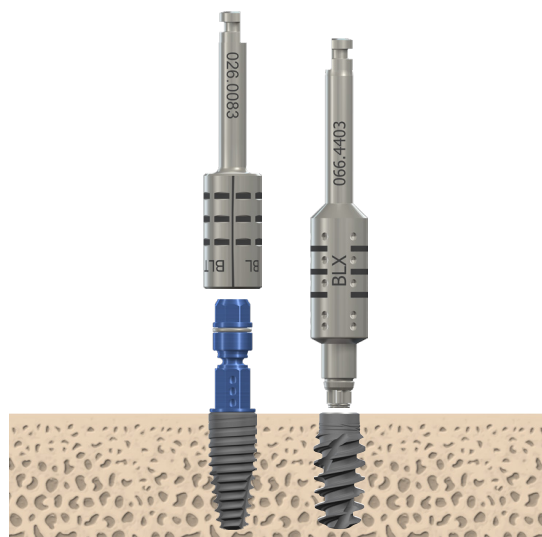

**Note:** The H4 or H6 T-sleeve position is recommended when planning to use guided Implant placement to ensure sufficient guiding contact between the Guided Adapter or the Guided Implant driver and the T-sleeve.

For further information, see Chapter 3.3 *Guided implant placement* on page 29.

**Note:** After removing the implant from the solution, the SLActive® surface treatment is chemically active for 15 minutes.

### 2.4.1 Guided implant insertion with a Straumann® Guided Adapter (Loxim® Transfer Piece)

The Straumann® Guided Adapter is designed to be mounted on Straumann® implants using a Loxim® Transfer Piece. The implant can be inserted through Straumann® Ø5.0 mm T-sleeves using visual depth control.

#### Caution:

- The Guided Adapter must be fully engaged with the Loxim® Transfer Piece to ensure depth control.
- When mounting the Guided Adapter on Straumann® Bone Level and Straumann® Bone Level Tapered Implants, ensure that the vertical lines on the Guided Adapter are aligned with the dots on the Loxim® Transfer Piece before engaging. This ensures correct prosthetic abutment orientation.

Align the cylindrical part of the Guided Adapter with the T-sleeve axis. Insert the implant with a maximum clockwise speed of 15 rpm. Use the visual depth control lines during insertion according to the planned T-sleeve position (H2, H4, H6). Note that the lower limit of each visual depth control line shows the correct insertion depth.

For all implants, if the resistance is still great, remove the implant, place the implant and implant driver back in the vial and widen the implant bed according to the drill protocol.

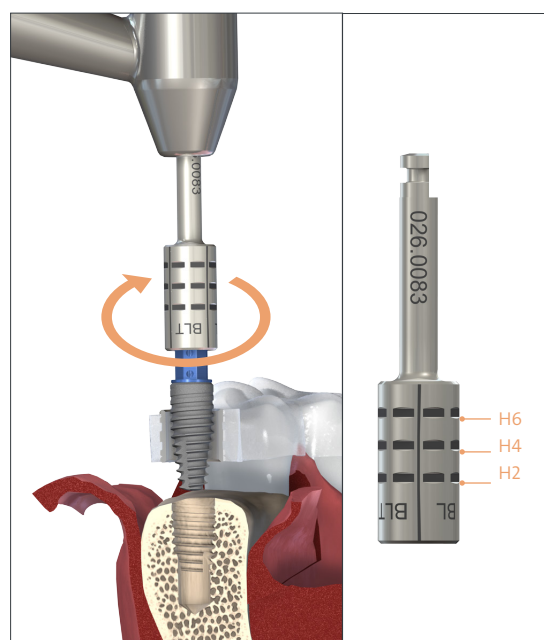

#### Guided indexing (if applicable)

For implants with CrossFit® connection, ensure that the final implant position has the four vertical lines matching the planned implant position marks on the Surgical Template.

The indexing marks on the Surgical Drill Template indicate where to align the rotational marker of the insertion tool to obtain the planned position of the temporary crown, bridge, or custom healing abutment.

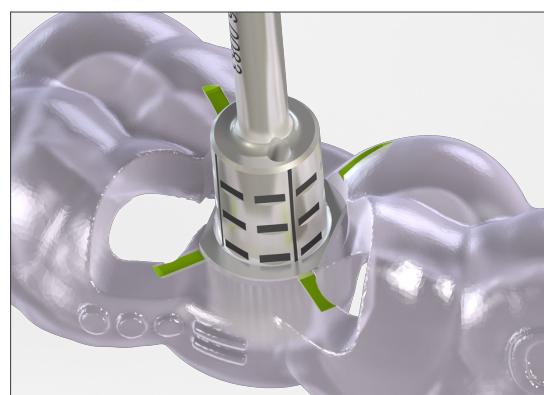

### 2.4.2 Guided implant insertion with a Guided Implant Driver (TorcFit™ Connection)

Pick up the implant from the vial and insert at a maximum clockwise speed of 15 rpm. The final implant position is indicated by the visual stop marks according to the planned T-sleeve position (H2, H4, H6) on the implant driver.

For the screw-retained guided implant drivers, a Stop Key (art. no. 034.006) can be used for a physical stop to indicate the final implant position. Use the Stop Key with the flat side pointing towards the T-sleeve.

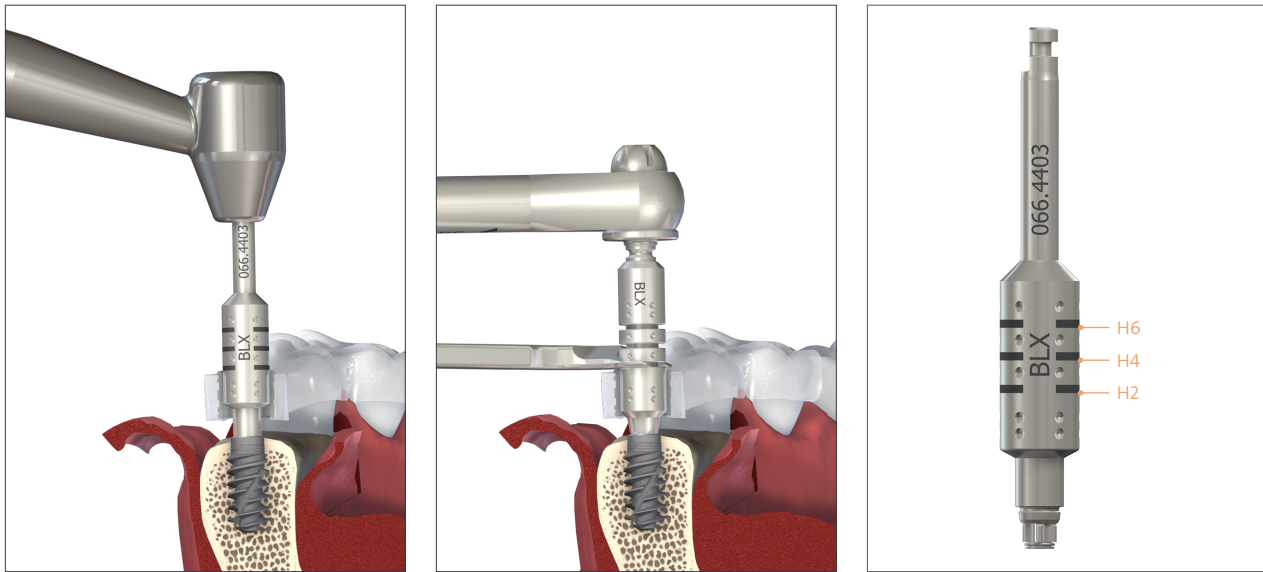

For BLX and TLX, if strong resistance is encountered before the implant reaches its final position, rotate the implant counterclockwise a few turns and continue to insert. Repeat this step several times if necessary.

For all implants, if the resistance is still too great, remove the implant, place the implant and implant driver back in the vial and widen the implant bed according to the drill protocol.

#### Guided indexing (if applicable)

The indexing marks on the Drill Guide indicate where to align the rotational marker of the insertion tool to achieve the planned position of the prosthetic components.

Once the implant is placed, gently pull the Guided Implant Driver out vertically. For a screw-retained Guided Implant Driver, loosen the fixation screw and gently pull out vertically.



#### Note:

- After removing the implant from the solution, the SLActive® surface treatment is chemically active for 15 minutes.
- With Straumann® guided instruments, increased insertion torques can occur due to precise osteotomy preparation.
- For immediate loading, a final torque of at least 35 Ncm should be achieved
- Excessive insertion torque must be avoided because this can lead to over-compression of the bone.

# 3. TECHNICAL INFORMATION ON STRAUMANN® GUIDED INSTRUMENTS

## 3.1 SURGICAL TEMPLATE AND GUIDED INSTRUMENTS

### 3.1.1 Surgical Template

Bone, mucosa or tooth-supported Surgical Templates (see figures) can be used depending on the clinician's preferences and the planning system used.

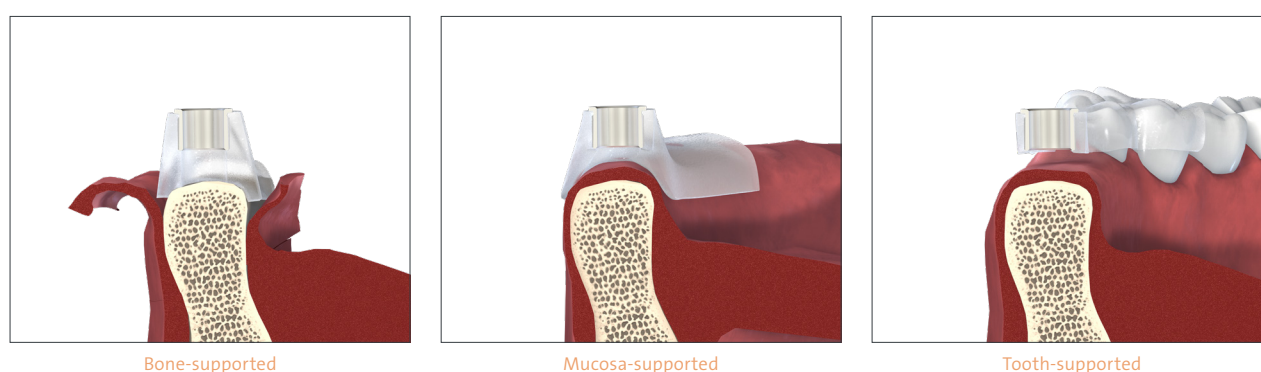

The Surgical Template must allow for proper irrigation of the surgical site. Windows may also be included in the Surgical Template. For a correct fit of the handle cylinder in the T-sleeve, remove additional material around the T-sleeve.

#### Caution:

- Ensure the T-sleeve is firmly fixed in the Surgical Template.
- Ensure the T-sleeve is fully seated in the template, with the rim in contact with the template.
- Radial and axial loads on the T-sleeve must be avoided to help ensure proper retention of the T-sleeves in the Surgical Template.
- On receipt of the Surgical Template from the manufacturer and prior to starting any surgical procedure, evaluate its fit and stability on the model and in the patient's mouth as well as the size and location of the openings for irrigation. Verify that the position and orientation of the T-sleeve in the Surgical Template match the preoperative plan and also verify that the right Drill Handles to fit into the selected T-sleeves are available (round or self-locking). Check product documentation if provided by the Surgical Template manufacturer.

### 3.1.2 T-sleeve types

Depending on the anatomical situation and the planned axis of adjacent implants, different T-sleeve diameters are available, for maximum precision use a metal T-Sleeve.

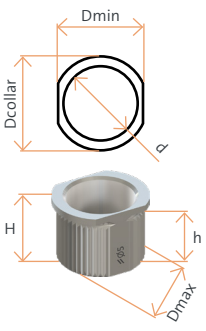
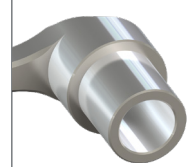
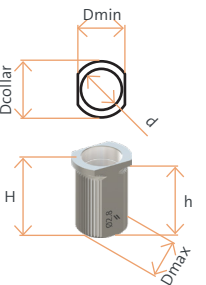
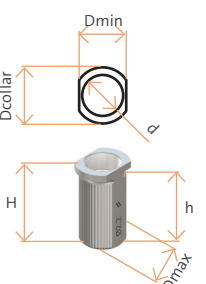
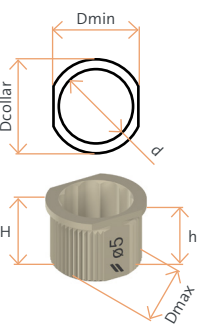
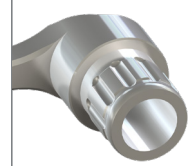
Article	Art. No./ material		Sleeve inner diameter	Sleeve outer diameter	Sleeve height	Use of drill handle
Ø 5 mm T-sleeve	034.053V4 stainless steel		d = 5 mm	Dmin = 5.7 mm Dcollar = 7.0 mm Dmax = 6.3 mm	H = 5 mm h = 4.5 mm	Yes 
Ø 2.8 mm T-sleeve	034.055V4 stainless steel		d = 2.8 mm	Dmin = 3.2 mm Dcollar = 4.4 mm Dmax = 3.8 mm	H = 6 mm h = 5.5 mm	No
Ø 2.2 mm T-sleeve	046.712V4 stainless steel		d = 2.2 mm	Dmin = 2.6 mm Dcollar = 3.8 mm Dmax = 3.2 mm	H = 6 mm h = 5.5 mm	No
Self-locking T-sleeve (compatible with self-locking Drill Handles)						
Ø 5 mm self locking T-sleeve	034.299V4 PEEK		d = 5 mm	Dmin = 6.0 mm Dcollar = 7.3 mm Dmax = 6.6 mm	H = 5 mm h = 4.5 mm	Yes 

**Caution:**







Make sure that for the implant surgery the right combination of sleeves and Drill handles is selected.

For more information go to Chapter 3.1.5 *Drill Handle* on page 20.

### 3.1.3 Vertical Template Fixation Pins

Vertical Template Fixation Pins can be used to stabilize the Surgical Template and prevent the cantilever effect while drilling multiple implant beds.

The pins are inserted after basic implant bed preparation is complete. A pin can be inserted into the implant bed socket to stabilize the guide before drilling the second implant site. The pin tip is designed to fit all implant types: S, SP, BL, BLT, BLX and TLX.

Article No.	Template fixation pin	Pin Diameter (mm)	Sleeve type
034.298		Ø2.8/2.8	Ø2.8 mm T-sleeve 034.055V4 034.052V4
034.285		Ø5/2.8	Ø5 mm T-sleeve 034.053V4 034.299V4 034.050V4
034.286		Ø5/3.2	
034.287		Ø5/3.5	
034.288		Ø5/3.7	
034.289		Ø5/4.2	

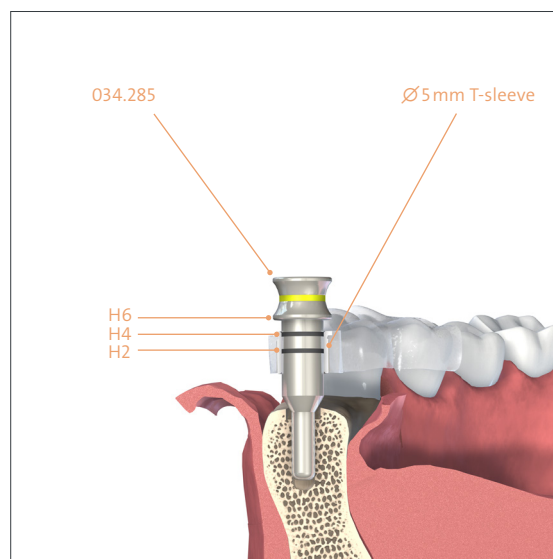

Vertical Template Fixation Pins have a visual depth mark corresponding to the selected T-sleeve position.



**Caution:** In case of flapless surgery, no force may be applied onto the Template Fixation Pins to avoid damage to the soft tissue. Secure the pins against aspiration.

### 3.1.4 Lateral Template Fixation Pins

Lateral Template Fixation Pins can be used to stabilize the guide where there is sufficient bone of adequate quality. The number of pins must be adapted to the anatomy, type of template and position of implants.

Orientation	Image	Article No.	Pin Diameter (mm)	Sleeve type
Lateral		034.282	Ø1.3	T-sleeve for fixation pin 034.283
		034.284		Drill for fixation pin 034.283

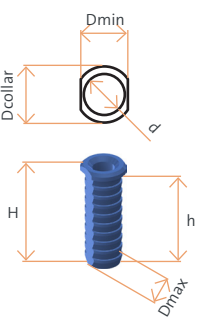
Article	Art. No.		Sleeve inner diameter	Sleeve outer diameter	Sleeve height	Use of drill handle
T-sleeve for Ø1.3 mm Template Fixation Pin	034.283		d = 1.35 mm	Dmin = 2.2 mm Dcollar = 3.1 mm Dmax = 2.5 mm	H = 7.5 mm h = 7 mm	No

To insert the pins, a T-sleeve for Template Fixation Pin (art. no. 034.283) and Drill for Template Fixation Pin (art. no. 034.284) are used.

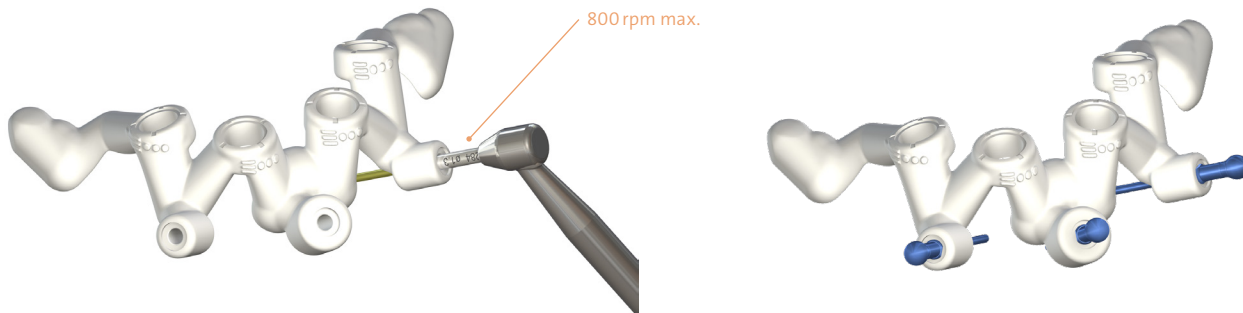

The number of pins must be adapted to the anatomy, type of template and position of implants. For examples of recommended positions, see figure below.

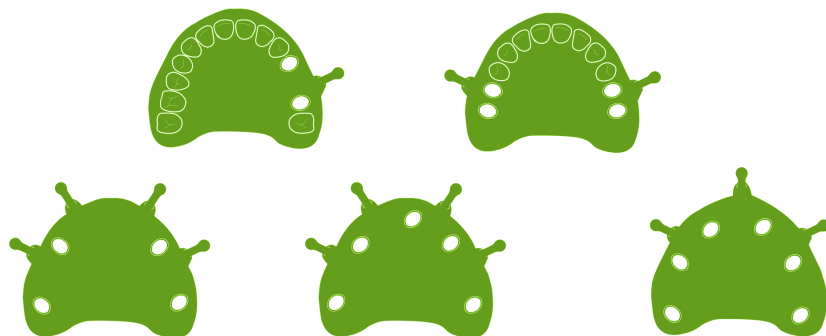

### 3.1.5 Drill Handle



For identification during surgery, Straumann® Guided Surgery Drill Handles are color-coded and marked with symbols for the respective cylinder height (one dot for 1 mm, 3 dots for 3 mm).

Art. No.	Image	Article
026.0147		Drill handle, Ø2.2 mm, 1 mm/3 mm
026.0148		Drill handle, Ø2.8 mm, 1 mm/3 mm
026.0149		Drill handle, Ø3.2 mm, 1 mm/3 mm
026.0150		Drill handle, Ø3.5 mm, 1 mm/3 mm
026.0151		Drill handle, Ø3.7 mm, 1 mm/3 mm
026.0152		Drill handle, Ø4.2 mm, 1 mm/3 mm

The planning software calculates the surgical protocol based on the virtual planning of implant placement and choice of T-sleeve types and positions. The surgical protocol recommends which Drill Handle cylinder (+1 mm or +3 mm) and which drill length (short, medium, or long) are required for preparing the osteotomy for each specific implant.

#### Self-locking Drill Handle, in combination with self-locking T-Sleeves (PEEK) only



- Drill Handles and T-Sleeves are also available in a self-locking version.
- Be aware that the self-locking Drill Handles are compatible with the self-locking sleeves only.
- The conventional Drill Handles with a round cylinder, are not compatible with the self-locking system.

	Conventional option	Self-locking option
	<p>Stainless steel T-sleeve 034.053V4</p>  <p>Round cylinder (new)</p>	<p>PEEK Self-locking T-sleeve 034.299V4</p>  <p>Self-locking cylinder</p>
Drill handle, Ø2.2 mm	026.0147	034.291
Drill handle, Ø2.8 mm	026.0148	034.292
Drill handle, Ø3.2 mm	026.0149	034.293
Drill handle, Ø3.5 mm	026.0150	034.294
Drill handle, Ø3.7 mm	026.0151	034.295
Drill handle, Ø4.2 mm	026.0152	034.296

**Caution:** Make sure that for the implant surgery the right combination of sleeves and Drill handles is selected.



### 3.1.6 Guided Adapter for profile drills, FIBA

Guided Adapters for profile drills (FIBA – Fine Implant Bed Adapters) are designed to work with FIBA-compatible short profile drills. These FIBA-compatible profile drills can be used in freehand cases, or in guided cases when used in conjunction with a Guided Adapter.

Art. No.	Picture	Article	Sleeve position
034.354		Guided Adapter for Profile Drill, FIBA, H2, handpiece, stainless steel	H2
034.355		Guided Adapter for Profile Drill, FIBA, H4, handpiece, stainless steel	H4
034.356		Guided Adapter for Profile Drill, FIBA, H6, handpiece, stainless steel	H6

### 3.1.7 Guided Adapter for taps, FIBA

Guided Adapters for taps (FIBA – Fine Implant Bed Adapters) are designed to work with FIBA-compatible taps. These FIBA-compatible taps can be used in freehand cases, or in guided cases when used in conjunction with a Guided Adapter.

Art. No.	Picture	Article	Sleeve position
034.357		Guided Adapter for Tap, FIBA, H2, handpiece, stainless steel	H2
034.358		Guided Adapter for Tap, FIBA, H4, handpiece, stainless steel	H4
034.359		Guided Adapter for Tap, FIBA, H6, handpiece, stainless steel	H6

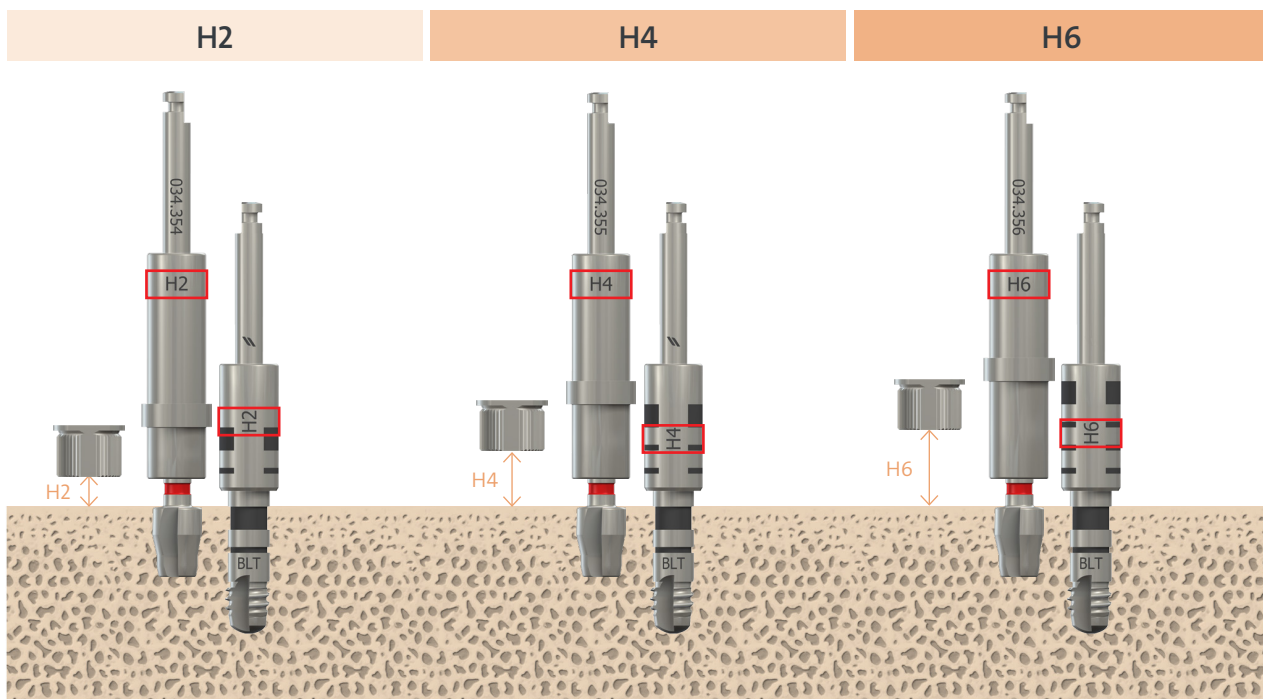

The Guided Adapters are laser-marked with the corresponding T-sleeve position (H2, H4, H6). Use the correct adapter according to the selected T-sleeve position as shown in the chart below.



## 3.2 CUTTING INSTRUMENTS

### 3.2.1 Mucosa Punch

For flapless surgery, the Mucosa Punch can be used through the 5.0 mm T-sleeve to punch through the gingiva for surgical access. The following table lists the mucosa punches available and their specifications.

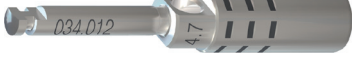

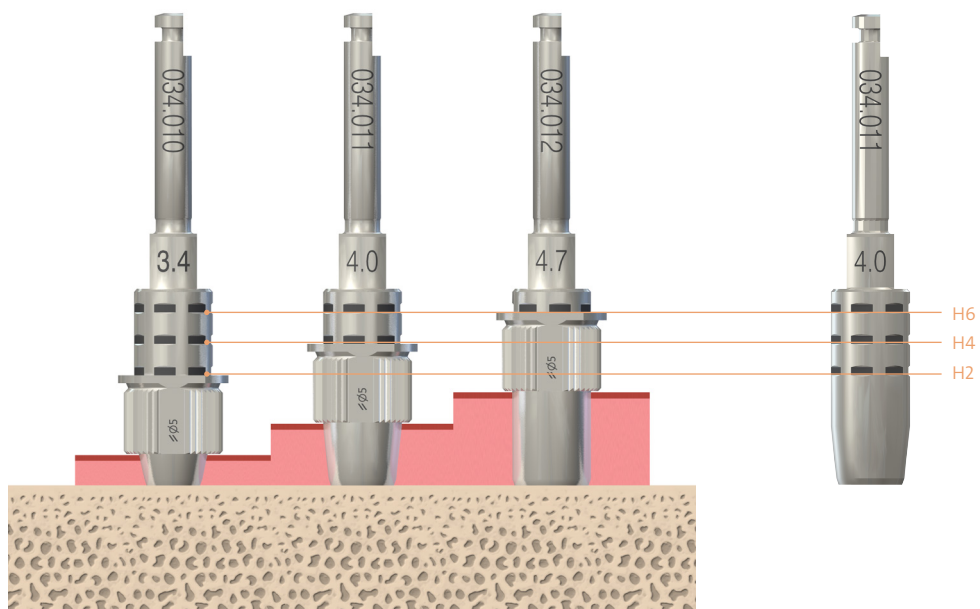

Art. No.	Picture	Article name	Max rpm.
034.010		Mucosa Punch, Ø3.4 mm, guided	15
034.011		Mucosa Punch, Ø4.0 mm, guided	
034.012		Mucosa Punch, Ø4.7 mm, guided	



### 3.2.2 Milling Cutter

Milling Cutter are to be used to create a flat bone surface and a sufficiently wide area of bone. The following table lists the Milling Cutter to be selected for each implant bed.

**Note:** Milling cutters have no stop. Milling cutters must only be used for flattening the alveolar ridge.

Art. No.	Picture	Article Name	Max rpm.	Endosteal implant diameter (mm)
026.0144		Milling Cutter, Ø 2.2 mm, guided	800	Ø 2.9
034.215		Milling Cutter, Ø 2.8 mm, guided	600	Ø 3.3 Ø 3.5
034.415		Milling Cutter, Ø 3.5 mm, guided	500	Ø 3.75 Ø 4.0 Ø 4.1
034.615		Milling Cutter, Ø 4.2 mm, guided	400	Ø 4.5 Ø 4.8

Choose the Milling Cutter and corresponding drill handle as indicated in the surgical protocol. Place the cylinder of the drill handle into the Sleeve in the surgical template. Insert the Milling Cutter into the cylinder until it contacts bone level. Prepare the alveolar ridge to the intended depth with the Milling Cutter. Use the 2 mm intervals laser-marked on the Milling Cutter as a depth reference.

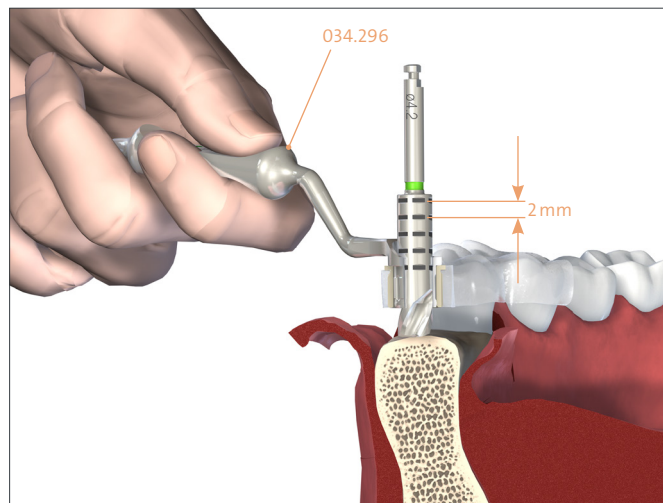

\* The Ø 4.2 mm Drill Handle and corresponding Ø 4.2 mm Milling Cutter are shown as an example.

### 3.2.3 Drills

Straumann® guided drills are color-coded by diameter and bear a symbol on the shaft to indicate their guided length (see figure below).

Identification	Picture	Name	Compatibility
1 color ring		Twist Drill PRO, guided	BL, TL
2 color rings		BLT Drills, guided	BLT
3 color rings		VeloDrill™, guided	TLX, BLX, BLT*

\* Thanks to the reduced diameter at the tip of the drill, the VeloDrill™ guided is also suitable for the implant bed preparation for BLT implants.

Drill name	Guided length	Overall length	Symbol for drill length
Short	16 mm	34 mm	—
Medium	20 mm	38 mm	≡
Long	24 mm	42 mm	≡≡≡

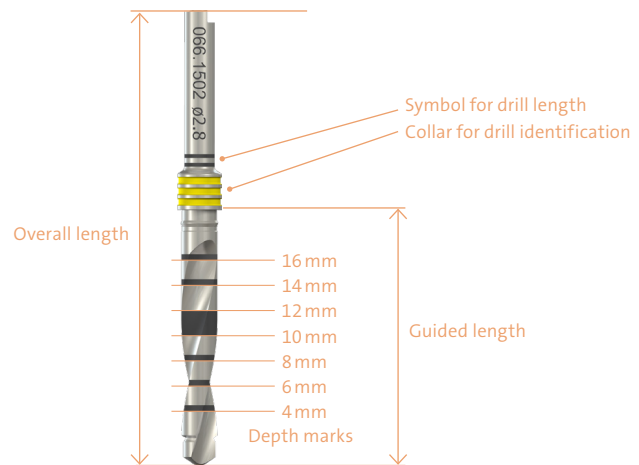

























Color coding and labeling of Straumann® cutting instruments for guided surgery:

Color-coding guided instruments		
Color sequence		Instrument diameter
	blue	∅2.2 mm
	yellow	∅2.8 mm
	white	∅3.2 mm
	red	∅3.5 mm
	grey	∅3.7 mm
	green	∅4.2 mm
	magenta	∅4.7 mm
	brown	∅5.2 mm
	black	∅6.2 mm

Guided surgery compatible

Freehand only













## Straumann® Twist Drills, guided

Art. No.	Picture	Article	Length	Symbol	Overall length	Guided length	Max rpm.
044.783*		Pilot Twist Drill PRO, Ø2.2 mm	short	-	32 mm	16 mm	800
034.123**		Pilot Drill, guided, Ø2.2 mm					
044.784*		Pilot Twist Drill PRO, Ø2.2 mm	medium	=	36 mm	20 mm	800
034.126**		Pilot Drill, guided, Ø2.2 mm					
044.785*		Pilot Twist Drill PRO, Ø2.2 mm	long	≡	40 mm	24 mm	800
034.129**		Pilot Drill, guided, Ø2.2 mm					
044.787*		Twist Drill PRO, Ø2.8 mm	short	-	32 mm	16 mm	600
034.223**		Twist Drill PRO, guided, Ø2.8 mm					
044.788*		Twist Drill PRO, Ø2.8 mm	medium	=	36 mm	20 mm	600
034.226**		Twist Drill PRO, guided, Ø2.8 mm					
044.789*		Twist Drill PRO, Ø2.8 mm	long	≡	40 mm	24 mm	600
034.229**		Twist Drill PRO, guided, Ø2.8 mm					
044.791*		Twist Drill PRO, Ø3.5 mm	short	-	32 mm	16 mm	500
034.423**		Twist Drill PRO, guided, Ø3.5 mm					
044.792*		Twist Drill PRO, Ø3.5 mm	medium	=	36 mm	20 mm	500
034.426**		Twist Drill PRO, guided, Ø3.5 mm					
044.793*		Twist Drill PRO, Ø3.5 mm	long	≡	40 mm	24 mm	500
034.429**		Twist Drill PRO, guided, Ø3.5 mm					
044.795*		Twist Drill PRO, Ø4.2 mm	short	-	32 mm	16 mm	400
034.623**		Twist Drill PRO, guided, Ø4.2 mm					
044.796*		Twist Drill PRO, Ø4.2 mm	medium	=	36 mm	20 mm	400
034.626**		Twist Drill PRO, guided, Ø4.2 mm					
044.797*		Twist Drill PRO, Ø4.2 mm	long	≡	40 mm	24 mm	400
034.629**		Twist Drill PRO, guided, Ø4.2 mm					























\* Not all products are available in all countries.

\*\* This article will be replaced with above article.

## Straumann® BLT Drill, guided

Art. No.	Picture	Article	Length	Symbol	Overall length	Guided length	Max rpm.
034.257		BLT Pilot Drill, Ø2.2 mm	short	-	33.4 mm	16 mm	800
034.258			medium	=	37.4 mm	20 mm	
034.259			long	≡	41.4 mm	24 mm	
034.260		BLT Drill, Ø2.8 mm	short	-	33.4 mm	16 mm	600
034.261			medium	=	37.4 mm	20 mm	
034.262			long	≡	41.4 mm	24 mm	
034.263		BLT Drill, Ø3.5 mm	short	-	33.4 mm	16 mm	500
034.264			medium	=	37.4 mm	20 mm	
034.265			long	≡	41.4 mm	24 mm	
034.266		BLT Drill, Ø4.2 mm	short	-	33.4 mm	16 mm	400
034.267			medium	=	37.4 mm	20 mm	
034.268			long	≡	41.4 mm	24 mm	









## Straumann® VeloDrill™, guided

Art. No.	Picture	Article	Length	Symbol	Maxrpm.
066.1301		Pilot VeloDrill™, guided, Ø2.2 mm	short	—	800
066.1501			medium	≡	
066.1701			long	≡≡	
066.1302		VeloDrill™, guided, Ø2.8 mm	short	—	
066.1502			medium	≡	
066.1702			long	≡≡	
066.1303		VeloDrill™, guided, Ø3.2 mm	short	—	
066.1503			medium	≡	
066.1703			long	≡≡	
066.1304		VeloDrill™, guided, Ø3.5 mm	short	—	
066.1504			medium	≡	
066.1704			long	≡≡	
066.1305		VeloDrill™, guided, Ø3.7 mm	short	—	
066.1505			medium	≡	
066.1705			long	≡≡	
066.1306		VeloDrill™, guided, Ø4.2 mm	short	—	
066.1506			medium	≡	
066.1706			long	≡≡	
066.1307		VeloDrill™, guided, Ø4.7 mm	short	—	
066.1707			long	≡≡	
066.1308		VeloDrill™, guided, Ø5.2 mm	short	—	
066.1309		VeloDrill™, guided, Ø6.2 mm	short	—	

**Note:** The cutting geometry of the Straumann® VeloDrill™ guided has been optimized to create less heat during drilling, therefore a universal drill speed of 800rpm for all diameter is recommended.

### 3.2.4 Profile Drills, FIBA compatible

Only profile drills labeled to be FIBA compatible are to be used with the Guided Adapter for profile drills, FIBA. Always use the correct Guided Adapter according to the T-sleeve position (H2, H4, H6). Using the incorrect Guided Adapter or non-FIBA compatible may cause incorrect drilling depth.

Art. No.	Picture	Article	Max rpm.
034.324		BLT Profile Drill, short, FIBA compatible, Ø 3.3 mm	300
034.325		BLT Profile Drill, short, FIBA compatible, Ø 4.1 mm	
034.326		BLT Profile Drill, short, FIBA compatible, Ø 4.8 mm	
034.327		BL/NNC Profile Drill, short, FIBA compatible, Ø 3.3 mm	
034.328		BL Profile Drill, short, FIBA compatible, Ø 4.1 mm	
034.329		BL Profile Drill, short, FIBA compatible, Ø 4.8 mm,	
034.332		SP Profile Drill, RN, short, FIBA compatible, Ø 3.3 mm	
034.333		SP Profile Drill, RN, short, FIBA compatible, Ø 4.1 mm	





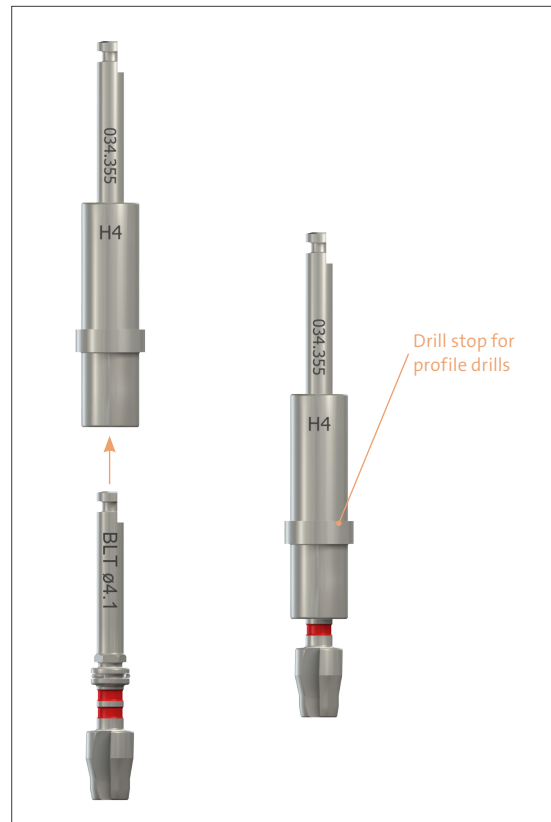



Use tweezers or Stop Key (art. no. 034.006) to engage and disengage the profile drill with the Guided Adapter to avoid touching the cutting part of the profile drill.

When the profile drill is inserted into the octagonal connection part in the Guided Adapter, there is an audible click as it engages. Shape the coronal part of the implant bed with the corresponding profile drill at the recommended max rpm speed. Always drill until the collar of the Guided Adapter hits the T-sleeve in order to reach the required depth.

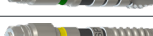

### 3.2.5 Taps, FIBA compatible

Only Taps labeled to be FIBA compatible are to be used with the Guided Adapter for taps, FIBA. Always use the correct Guided Adapter according to the T-sleeve position (H2, H4, H6). Using the incorrect Guided Adapter or non-FIBA compatible may result in an incorrect drilling depth.

Art. No.	Picture	Article	Max rpm.
034.345		BLT Tap, short, FIBA compatible, Ø 3.3 mm	15
034.346		BLT Tap, short, FIBA compatible, Ø 4.1 mm	
034.347		BLT Tap, short, FIBA compatible, Ø 4.8 mm	
034.348		BL/NNC Tap, short, FIBA compatible, Ø 3.3 mm	
034.349		BL Tap, short, FIBA compatible, Ø 4.1 mm	
034.350		BL Tap, short, FIBA compatible, Ø 4.8 mm	
034.351		S/SP Tap, short, FIBA compatible, Ø 3.3 mm	
034.352		S/SP Tap, short, FIBA compatible, Ø 4.1 mm	
034.353		S/SP Tap, short, FIBA compatible, Ø 4.8 mm	

When the Tap is inserted into the octagonal connection part in the Guided Adapter, there is an audible click as it engages.

Use the laser marks on the Guided Adapter for depth reference (2mm intervals). The maximum recommended speed is 15 rpm.

**Caution:** Do not apply torque greater than 60 Ncm. Torque values above 60 Ncm can result in damage to the tap.

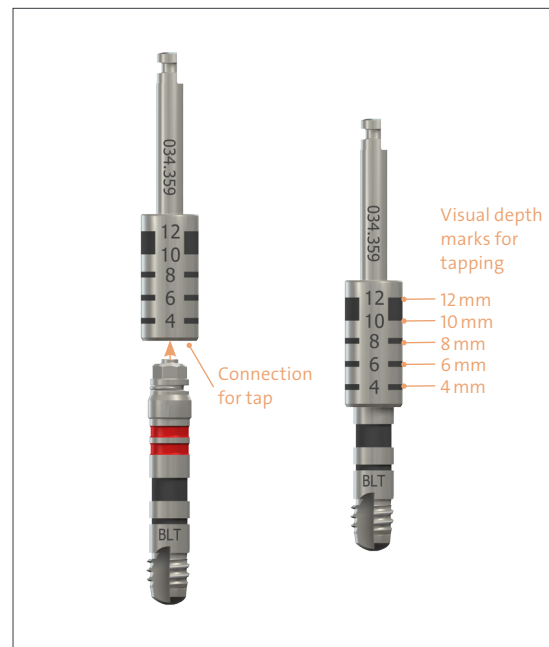

### 3.3 GUIDED IMPLANT PLACEMENT

#### 3.3.1 Guided Adapter for the Loxim® Transfer Piece

The Guided Adapter is designed to be mounted on Straumann® implants using a Loxim® Transfer Piece; the implants should be inserted through a Straumann® Ø5.0 mm T-sleeve. The Guided Adapter provides visual depth control and can be used either with the aid of the handpiece, or manually using the ratchet.

The laser markings on the Guided Adapter are provided for identification. Please be aware that the correct Guided Adapter must be used for the corresponding implant type. Using the wrong Guided Adapter type could result in placing the implant deeper than planned.

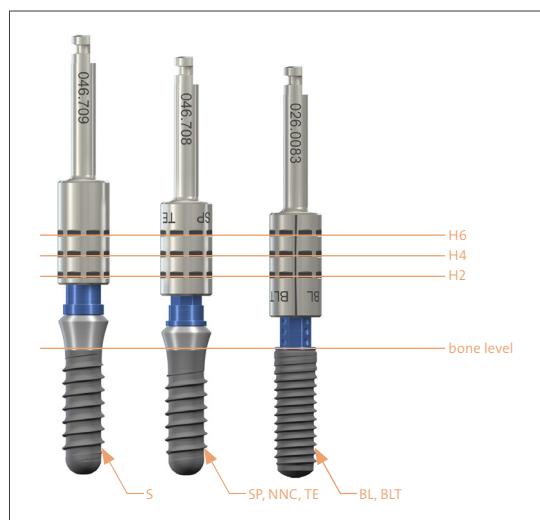

Art. No.	Picture	Article
046.708		SP/NNC/TE Guided Adapter, for handpiece
046.709		S Guided Adapter, for handpiece
026.0083		BL/BLT Guided Adapter, for handpiece (Not compatible with Straumann® BLT Ø2.9 mm SC)
046.710		SP/NNC/TE Guided Adapter, for ratchet
046.711		S Guided Adapter, for ratchet
026.0084		BL/BLT Guided Adapter, for ratchet (Not compatible with Straumann® BLT Ø2.9 mm SC)

**Note:** Due to a different height of the Loxim® Transfer Piece, the Straumann® Bone Level Tapered Ø2.9 mm Small CrossFit® connection shall not be placed guided using the BL/BLT Guided Adapter. The markings on the Adapter give an incorrect height reading for the BLT Ø2.9 mm.

## Implant pick-up

**Step 1** – Attach the Guided Adapter to the Loxim® Transfer Piece

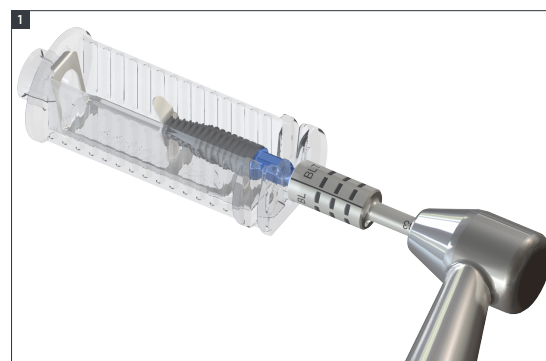

**Step 2** – For implants with CrossFit® connection (BL/BLT), ensure the vertical lines on the Guided Adapter are aligned with the dots on the Loxim® Transfer Piece.

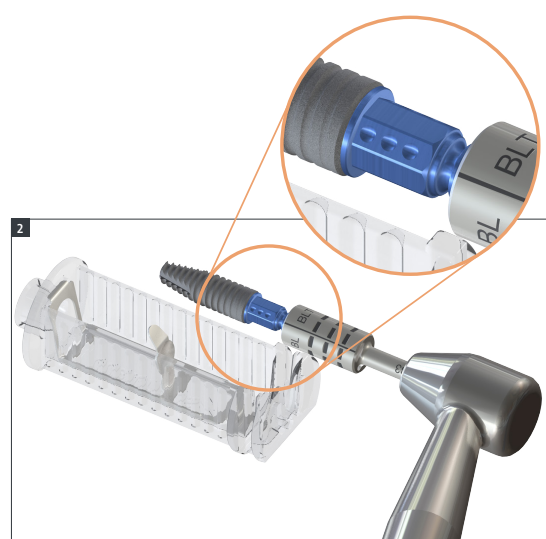

**Step 3** – Remove the implant from the carrier and push it against the titanium implant stopper plate for correct attachment of the Guided Adapter. A click will be heard when the Guided Adapter is attached correctly.

The Guided Adapter must be fully engaged with the Loxim® Transfer Piece to ensure depth control.

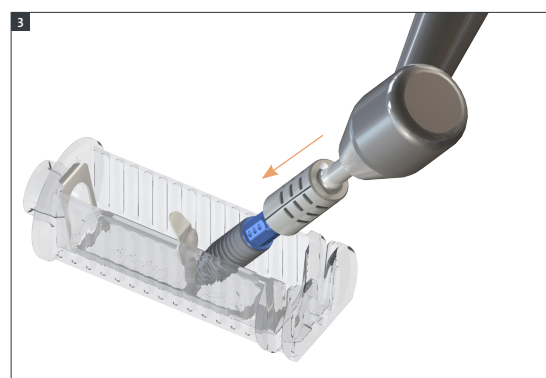







**Note:** If the implant needs to be removed during implantation surgery, the Loxim® Transfer Piece allows for counterclockwise rotation. If the Loxim® Transfer Piece has been removed, it can easily be re-inserted to complete an incomplete implant placement.

The Loxim® Transfer Piece is provided with a pre-determined breaking point to prevent the implant's inner configuration from damage, thus ensuring the integrity of the interface to mount the prosthesis. If the Loxim® Transfer Piece breaks during implant insertion, do not continue to use the Guided Adapter but change to a conventional adapter. For further details, please consult the brochure *Straumann® Dental Implant System, Basic Information (702084/en)* in the section *Additional information for implants with the Loxim® Transfer Piece*.

### 3.3.2 Guided Implant Driver

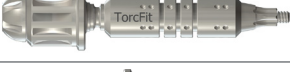
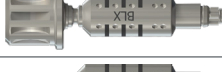
The Guided Implant Driver has depth marks for the H2, H4 and H6 T-sleeve positions. Before implant placement, consult the surgical protocol and confirm that the T-sleeve position matches the implant site. The laser markings on the guided implant drivers are provided for identification. Please be aware that the correct guided implant drivers must be used for the corresponding implant type (S TLX, SP TLX, BLX). Using the wrong type could result in implant placement deeper than planned.

Art. No.	Picture	Article	Compatibility
037.3000		TLX/TLC Guided Implant Driver, ratchet, S	TLX, S
037.3001		TLX/TLC Guided Implant Driver, handpiece, S	
037.3002		TLX/TLC Guided Implant Driver, ratchet, SP	TLX, SP
037.3003		TLX/TLC Guided Implant Driver, handpiece, SP	
066.4401		BLX/BLC Guided Implant Driver, ratchet, screw-retained	BLX
066.4404		BLX/BLC Guided Implant Driver, ratchet	
066.4403		BLX/BLC Guided Implant Driver, handpiece	

#### Implant pick-up

The BLX Implants are provided with a new implant carrying system that supports direct pick-up with an appropriate Implant Driver.

**Step 1** – Hold the vial lid and connect the Implant Driver to the implant using the handpiece. You hear a click when the Driver is attached correctly.

**Caution:** Make sure that the implant driver is properly seated and pull slightly on the driver to verify that it is correctly attached. Replace the driver with a new one if insufficient attachment occurs.

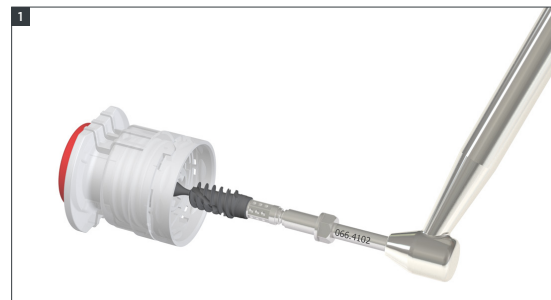

**Step 2** – A slight clockwise turn is needed to remove the implant from its holder.

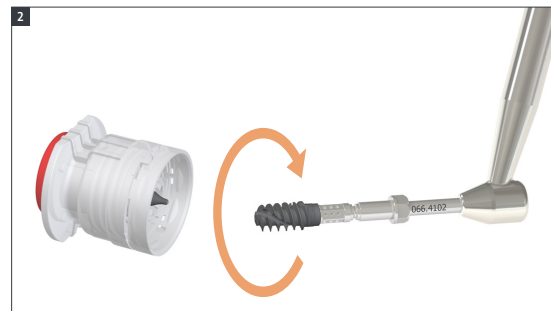

#### Stop Key

For the BLX screw-retained Guided Implant Driver for Ratchet (066.4401), a Stop Key (034.006) can be used for a physical stop to indicate the final implant position. Use the Stop Key with the flat side pointing towards the T-sleeve.

Art. No.	Picture
034.006	

# 4. STRAUMANN® DENTAL IMPLANT PORTFOLIO FOR GUIDED SURGERY





The following table provides the overview of the Straumann® dental implant portfolio.



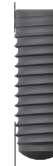
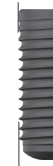

- Implants colored in **green** are compatible with the fully guided workflow.
- Implants colored in **blue** are too wide to fit through the Ø5.0 mm T-sleeves. Remove the Surgical Template after guided implant bed preparation and place the implant freehand.
- Implant colored in **yellow** offer guided pilot drilling only.

For short implants (4 mm and 6 mm) and long implants (14 mm and 16 mm) not all T-sleeve positions are possible; available positions are indicated in the table (refer to Chapter 5. *T-sleeve position/implant length matrix* on page 34).

18 mm long implants cannot be placed using guided surgery.

Bone Level Implants		NC	RC		
		Ø 3.3 mm  Ø 3.3 mm	Ø 4.1 mm  Ø 4.1 mm	Ø 4.8 mm  Ø 4.8 mm	
		BL Ø 3.3 NC	BL Ø 4.1 RC	BL Ø 4.8 RC	
8 mm					
10 mm					
12 mm					
14 mm		H2/H4	H2/H4	H2/H4	

Bone Level Tapered Implants	SC	NC	RC		
	Ø 2.9 mm 	Ø 3.3 mm 	Ø 4.1 mm 	Ø 4.8 mm 	
	BLT Ø 2.9 SC	BLT Ø 3.3 NC	BLT Ø 4.1 RC	BLT Ø 4.8 RC	
8 mm					
10 mm					
12 mm					
14 mm	H2/H4	H2/H4	H2/H4	H2/H4	
16 mm		H2	H2	H2	
18 mm		18 mm implants cannot be placed guided			

BLX Implants	RB				WB		
	Ø 3.4 mm 	Ø 3.5 mm 			Ø 4.5 mm 		
	BLX Ø 3.5 RB	BLX Ø 3.75 RB	BLX Ø 4.0 RB	BLX Ø 4.5 RB	BLX Ø 5.0 WB	BLX Ø 5.5 WB	BLX Ø 6.5 WB
6 mm							
8 mm							
10 mm							
12 mm							
14 mm		H2/H4	H2/H4	H2/H4	H2/H4	H2/H4	H2/H4
16 mm		H2	H2	H2	H2	H2	H2
18 mm	18 mm implants cannot be placed guided						

Tissue Level Standard Implants		RN	RN	RN	WN*
		∅ 4.8 mm ∅ 3.3 mm	∅ 4.8 mm ∅ 4.1 mm	∅ 4.8 mm ∅ 4.8 mm	∅ 6.5 mm ∅ 4.8 mm
		S ∅ 3.3 RN	S ∅ 4.1 RN	S ∅ 4.8 RN	S ∅ 4.8 WN
6 mm					
8 mm					
10 mm					
12 mm					
14 mm		H2/H4	H2/H4	H2/H4	
16 mm		H2	H2		

Tissue Level Standard Plus Implants		NNC	RN	RN	RN	WN*
		∅ 3.5 mm ∅ 3.3 mm	∅ 4.8 mm ∅ 3.3 mm	∅ 4.8 mm ∅ 4.1 mm	∅ 4.8 mm ∅ 4.8 mm	∅ 6.5 mm ∅ 4.8 mm
		SP ∅ 3.3 NNC	SP ∅ 3.3 RN	SP ∅ 4.1 RN	SP ∅ 4.8 RN	SP ∅ 4.8 WN
4 mm				H4/H6	H4/H6	H4/H6
6 mm						
8 mm						
10 mm						
12 mm						
14 mm		H2/H4	H2/H4	H2/H4	H2/H4	

TLX Implants Standard TLX Implants Standard Plus	NT	RT	NT	RT	WT*	
	∅ 3.5 mm	∅ 4.8 mm	∅ 3.5 mm	∅ 4.8 mm	∅ 6.5 mm	
	S/SP ∅ 3.5 NT	S/SP ∅ 3.75 RT	S/SP ∅ 4.5 NT	S/SP ∅ 4.5 RT	S/SP ∅ 5.5 WT	S/SP ∅ 6.5 WT
6 mm						
8 mm						
10 mm						
12 mm						
14 mm	H2/H4	H2/H4	H2/H4	H2/H4		
16 mm	H2	H2	H2	H2		
18 mm	18 mm implants cannot be placed guided					

\* For WN and WT (∅ 6.5 mm) remove the template for freehand profile drilling.

**Note:** Guided handles are compatible up to ∅ 4.2 mm. For drills with ∅ 4.7 mm and larger remove the template for freehand drilling.

# 5. T-SLEEVE POSITION AND IMPLANT LENGTH MATRIX

## 5.1 T-SLEEVES Ø 5.0 MM

Implant length		4 mm	6 mm	8 mm	10 mm	12 mm	14 mm	16 mm
Sleeve position	H2 2 mm		Short drill — +3 handle ●●●	Short drill — +1 handle ●	Medium drill = +3 handle ●●●	Medium drill = +1 handle ●	Long drill ≡ +3 handle ●●●	Long drill ≡ +1 handle ●
	H4 4 mm	Short drill — +3 handle ●●●	Short drill — +1 handle ●	Medium drill = +3 handle ●●●	Medium drill = +1 handle ●	Long drill ≡ +3 handle ●●●	Long drill ≡ +1 handle ●	
	H6 6 mm	Short drill — +1 handle ●	Medium drill = +3 handle ●●●	Medium drill = +1 handle ●	Long drill ≡ +3 handle ●●●	Long drill ≡ +1 handle ●		

**Note:** Avoid planning 6 mm and 8 mm BLX and TLX implants in the H2 T-sleeve position, since 4 mm of guided drilling is not possible in the H2 position. Instead, remove the template and continue drilling using conventional procedures.

## 5.2 CORONAL WIDENING

Implant length		Coronal-widening implant 6-8 mm	Coronal-widening implant 10-18 mm
Sleeve position	H2 2 mm		Short drill — +3 handle ●●●
	H4 4 mm	Short drill — +3 handle ●●●	Short drill — +1 handle ●
	H6 6 mm	Short drill — +1 handle ●	Medium drill = +3 handle ●●●

### 5.3 T-SLEEVES Ø 2.8 MM (NARROW INTERDENTAL SPACE)

The Ø 2.8 mm T-sleeve has a height of 6 mm. This is the equivalent of adding the +1 mm cylinder height to the 5.0 mm T-sleeve height. Hence no drill handles are required.

Implant length		6 mm	8 mm	10 mm	12 mm	14 mm	16 mm
Sleeve position	H2 2 mm		Short drill — No handle		Medium drill = No handle		Long drill ≡ No handle
	H4 4 mm	Short drill — No handle		Medium drill = No handle		Long drill ≡ No handle	
	H6 6 mm		Medium drill = No handle		Long drill ≡ No handle		

### 5.4 T-SLEEVES Ø 2.2 MM (PILOT GUIDED)

The Ø 2.2 mm T-sleeve has a height of 6 mm. This is the equivalent of adding the +1 mm cylinder height to the 5.0 mm T-sleeve height. Hence no drill handles are required.

Implant length		6 mm	8 mm	10 mm	12 mm	14 mm	16 mm
Sleeve position	H2 2 mm		Short drill — No handle		Medium drill = No handle		Long drill ≡ No handle
	H4 4 mm	Short drill — No handle		Medium drill = No handle		Long drill ≡ No handle	
	H6 6 mm		Medium drill = No handle		Long drill ≡ No handle		

# 6. RELATED DOCUMENTS











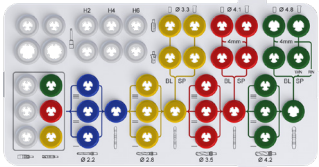



















For further information, please consult the following brochures:

- *Straumann® Dental Implant System, Basic Information (702084/en)*
- *Straumann® Bone Level Tapered Implant, Basic Information (702167/en)*
- *Straumann® BLX Implant System, Basic Information (702115/en)*
- *Straumann® TLX Implant System, Basic Information (702854/en)*
- *Straumann® Modular Cassette, Basic Information (702527/en)*
- *Straumann® Modular Cassette, Selection Guide (702824/en)*
- *Straumann® Surgical and Prosthetic Instruments, Care and maintenance (702000/en)*
- *Guidance for Implant Removal, Basic Information (702085/en)*
- *Straumann® Guided Surgery (702083/en) - Guided Surgery System with C-Handles*

# 7. ARTICLE LIST – INSTRUMENTS FOR GUIDED SURGERY















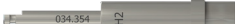

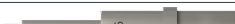









For Surgical Kit set up refer to the *Modular Cassette Selection Guide (702824/en)*.

## 7.1 GUIDED SURGERY WITH TISSUE LEVEL IMPLANTS (TL S/TL SP)

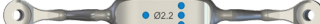
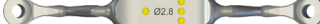
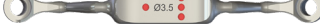
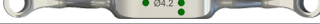
Art. No.	Picture	Article
<b>B Module</b>		
041.776		Straumann® Modular Cassette, B Module
041.782		B Module, Guided Parallel Walled Tray
034.010		Mucosa Punch Ø 3.4 mm, 30 mm, guided
034.011		Mucosa Punch Ø 4.0 mm, 30 mm, guided
034.012		Mucosa Punch Ø 4.7 mm, 30 mm, guided
034.215		Milling Cutter, Ø 2.8 mm, 32.5 mm, guided
034.415		Milling Cutter, Ø 3.5 mm, 32.5 mm, guided
034.615		Milling Cutter, Ø 4.2 mm, 32.5 mm, guided
044.783*		Pilot Twist Drill PRO, Ø 2.2 mm, short
034.123**		Pilot Drill, guided, Ø 2.2 mm, short
044.784*		Pilot Twist Drill PRO, Ø 2.2 mm, medium
034.126**		Pilot Drill, guided, Ø 2.2 mm, medium
044.785*		Pilot Twist Drill PRO, Ø 2.2 mm, long
034.129**		Pilot Drill, guided, Ø 2.2 mm, long
044.787*		Twist Drill PRO, Ø 2.8 mm, short
034.223**		Twist Drill PRO, guided, Ø 2.8 mm, short
044.788*		Twist Drill PRO, Ø 2.8 mm, medium
034.226**		Twist Drill PRO, guided, Ø 2.8 mm, medium
044.789*		Twist Drill PRO, Ø 2.8 mm, long
034.229**		Twist Drill PRO, guided, Ø 2.8 mm, long
044.791*		Twist Drill PRO, Ø 3.5 mm, short
034.423**		Twist Drill PRO, guided, Ø 3.5 mm, short
044.792*		Twist Drill PRO, Ø 3.5 mm, medium
034.426**		Twist Drill PRO, guided, Ø 3.5 mm, medium
044.793*		Twist Drill PRO, Ø 3.5 mm, long
034.429**		Twist Drill PRO, guided, Ø 3.5 mm, long
044.795*		Twist Drill PRO, Ø 4.2 mm, short
034.623**		Twist Drill PRO, guided, Ø 4.2 mm, short
044.796*		Twist Drill PRO, Ø 4.2 mm, medium
034.626**		Twist Drill PRO, guided, Ø 4.2 mm, medium
044.797*		Twist Drill PRO, Ø 4.2 mm, long
034.629**		Twist Drill PRO, guided, Ø 4.2 mm, long

\* Not all products are available in all countries.

\*\* This article will be replaced with above article.











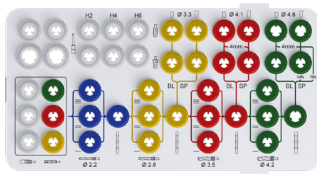



















Art. No.	Picture	Article
<b>B Module</b>		
046.799		Alignment Pin, Ø2.2 mm, L27 mm, TAN
046.800		Depth Gauge, Ø2.8 mm, L27 mm, TAN
046.802		Depth Gauge, Ø3.5 mm, L27 mm, TAN
046.804		Depth Gauge, Ø4.2 mm, L27 mm, TAN
034.354		Guided Adapter for Profile Drill, FIBA, H2, handpiece, stainless steel
034.355		Guided Adapter for Profile Drill, FIBA, H4, handpiece, stainless steel
034.356		Guided Adapter for Profile Drill, FIBA, H6, handpiece, stainless steel
034.357		Guided Adapter for Tap, FIBA, H2, handpiece, stainless steel
034.358		Guided Adapter for Tap, FIBA, H4, handpiece, stainless steel
034.359		Guided Adapter for Tap, FIBA, H6, handpiece, stainless steel
034.005		Connector for Ratchet
034.332		SP Profile Drill, RN, short, FIBA compatible, Ø3.3 mm, L 25 mm, stainless steel
034.333		SP Profile Drill, RN, short, FIBA compatible, Ø4.1 mm, L 25 mm, stainless steel
044.084		SP profile drill, WN, Ø4.8 mm, short, L 23.8 mm, stainless steel
034.351		S/SP Tap, short, FIBA compatible, Ø3.3 mm, L22, stainless steel
034.352		S/SP Tap, short, FIBA compatible, Ø4.1 mm, L22, stainless steel
034.353		S/SP Tap, short, FIBA compatible, Ø4.8 mm, L22, stainless steel
046.708		SP/NNC/TE Guided Adapter, for handpiece
046.710		SP/NNC/TE Guided Adapter, for ratchet
<b>C Module</b>		
041.772		Straumann® ModularCassette, C Module, Guided Surgery
026.0147		Drill Handle, Ø2.2 mm, 1 mm/3 mm stop, stainless steel
026.0148		Drill Handle, Ø2.8 mm, 1 mm/3 mm stop, stainless steel
026.0150		Drill Handle, Ø3.5 mm, 1 mm/3 mm stop, stainless steel
026.0152		Drill Handle, Ø4.2 mm, 1 mm/3 mm stop, stainless steel
034.284		Drill for Template Fixation Pin, Ø1.3 mm
034.282		Template Fixation Pin, Ø1.3 mm
034.298		Template Fixation Pin, Ø2.8/2.8 mm, guided
034.285		Template Fixation Pin, Ø5/2.8, guided, stainless steel
034.287		Template Fixation Pin, Ø5/3.5, guided, stainless steel
034.289		Template Fixation Pin, Ø5/4.2, guided, stainless steel

**Caution:**

Make sure that the right combination of sleeves and Drill handles is selected.

















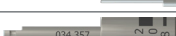

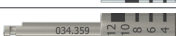







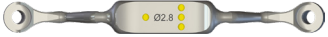

For more information go to Chapter 3.1.5 *Drill Handle* on page 20.

## 7.2 GUIDED SURGERY WITH BONE LEVEL IMPLANTS (BL)

Art. No.	Picture	Article
<b>B Module</b>		
041.776		Straumann® Modular Cassette, B Module
041.782		B Module, Guided Parallel Walled Tray
034.010		Mucosa Punch Ø 3.4 mm, 30 mm, guided
034.011		Mucosa Punch Ø 4.0 mm, 30 mm, guided
034.012		Mucosa Punch Ø 4.7 mm, 30 mm, guided
034.215		Milling Cutter, Ø 2.8 mm, 32.5 mm, guided
034.415		Milling Cutter, Ø 3.5 mm, 32.5 mm, guided
034.615		Milling Cutter, Ø 4.2 mm, 32.5 mm, guided
044.783*		Pilot Twist Drill PRO, Ø 2.2 mm, short
034.123**		Pilot Drill, guided, Ø 2.2 mm, short
044.784*		Pilot Twist Drill PRO, Ø 2.2 mm, medium
034.126**		Pilot Drill, guided, Ø 2.2 mm, medium
044.785*		Pilot Twist Drill PRO, Ø 2.2 mm, long
034.129**		Pilot Drill, guided, Ø 2.2 mm, long
044.787*		Twist Drill PRO, Ø 2.8 mm, short
034.223**		Twist Drill PRO, guided, Ø 2.8 mm, short
044.788*		Twist Drill PRO, Ø 2.8 mm, medium
034.226**		Twist Drill PRO, guided, Ø 2.8 mm, medium
044.789*		Twist Drill PRO, Ø 2.8 mm, long
034.229**		Twist Drill PRO, guided, Ø 2.8 mm, long
044.791*		Twist Drill PRO, Ø 3.5 mm, short
034.423**		Twist Drill PRO, guided, Ø 3.5 mm, short
044.792*		Twist Drill PRO, Ø 3.5 mm, medium
034.426**		Twist Drill PRO, guided, Ø 3.5 mm, medium
044.793*		Twist Drill PRO, Ø 3.5 mm, long
034.429**		Twist Drill PRO, guided, Ø 3.5 mm, long
044.795*		Twist Drill PRO, Ø 4.2 mm, short
034.623**		Twist Drill PRO, guided, Ø 4.2 mm, short
044.796*		Twist Drill PRO, Ø 4.2 mm, medium
034.626**		Twist Drill PRO, guided, Ø 4.2 mm, medium
044.797*		Twist Drill PRO, Ø 4.2 mm, long
034.629**		Twist Drill PRO, guided, Ø 4.2 mm, long

\* Not all products are available in all countries.

\*\* This article will be replaced with above article.











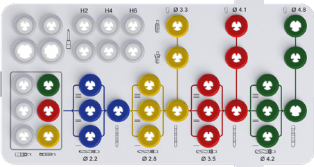













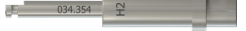
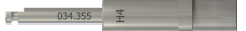

Art. No.	Picture	Article
<b>B Module</b>		
046.799		Alignment Pin, Ø 2.2 mm, L27 mm, TAN
046.800		Depth Gauge, Ø 2.8 mm, L27 mm, TAN
046.802		Depth Gauge, Ø 3.5 mm, L27 mm, TAN
046.804		Depth Gauge, Ø 4.2 mm, L27 mm, TAN
034.354		Guided Adapter for Profile Drill, FIBA, H2, handpiece, stainless steel
034.355		Guided Adapter for Profile Drill, FIBA, H4, handpiece, stainless steel
034.356		Guided Adapter for Profile Drill, FIBA, H6, handpiece, stainless steel
034.357		Guided Adapter for Tap, FIBA, H2, handpiece, stainless steel
034.358		Guided Adapter for Tap, FIBA, H4, handpiece, stainless steel
034.359		Guided Adapter for Tap, FIBA, H6, handpiece, stainless steel
034.327		BL/NNC Profile Drill, short, FIBA compatible, Ø 3.3 mm, L 28 mm, stainless steel
034.328		BL Profile Drill, short, FIBA compatible, Ø 4.1 mm, L 28 mm, stainless steel
034.329		BL Profile Drill, short, FIBA compatible, Ø 4.8 mm, L 28 mm, stainless steel
034.348		BL/NNC Tap, short, FIBA compatible, Ø 3.3 mm, L 22 mm, stainless steel
034.349		BL Tap, short, FIBA compatible, Ø 4.1 mm, L 22 mm, stainless steel
034.350		BL Tap, short, FIBA compatible, Ø 4.8 mm, L 22 mm, stainless steel
034.005		Connector for Ratchet
026.0083		BL/BLT Guided Adapter, for Handpiece
026.0084		BL/BLT Guided Adapter, for Ratchet
<b>C Module</b>		
041.772		Straumann® ModularCassette, C Module, Guided Surgery
026.0147		Drill Handle, Ø 2.2 mm, 1 mm/3 mm stop, stainless steel
026.0148		Drill Handle, Ø 2.8 mm, 1 mm/3 mm stop, stainless steel
026.0150		Drill Handle, Ø 3.5 mm, 1 mm/3 mm stop, stainless steel
026.0152		Drill Handle, Ø 4.2 mm, 1 mm/3 mm stop, stainless steel
034.284		Drill for Template Fixation Pin, Ø 1.3 mm
034.282		Template Fixation Pin, Ø 1.3 mm
034.298		Template Fixation Pin, Ø 2.8/2.8 mm, guided
034.285		Template Fixation Pin, Ø 5/2.8 mm, guided, stainless steel
034.287		Template Fixation Pin, Ø 5/3.5 mm, guided, stainless steel
034.289		Template Fixation Pin, Ø 5/4.2 mm, guided, stainless steel

**Caution:**

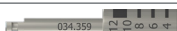











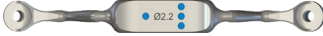
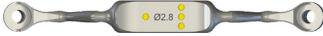
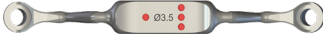

Make sure that the right combination of sleeves and Drill handles is selected.

For more information go to Chapter 3.1.5 *Drill Handle* on page 20.

## 7.3 GUIDED SURGERY WITH BONE LEVEL TAPERED IMPLANTS (BLT)

Art. No.	Picture	Article
<b>B Module</b>		
041.776		Straumann® Modular Cassette, B Module
041.781		B Module, Guided Basic Tray
034.010		Mucosa Punch Ø 3.4 mm, 30 mm, guided
034.011		Mucosa Punch Ø 4.0 mm, 30 mm, guided
034.012		Mucosa Punch Ø 4.7 mm, 30 mm, guided
034.215		Milling Cutter, Ø 2.8 mm, 32.5 mm, guided
034.415		Milling Cutter, Ø 3.5 mm, 32.5 mm, guided
034.615		Milling Cutter, Ø 4.2 mm, 32.5 mm, guided
034.257		BLT Drill, short, guided, length 33.4 mm, Ø 2.2 mm
034.258		BLT Drill, medium, guided, length 37.4 mm, Ø 2.2 mm
034.259		BLT Drill, long, guided, length 41.4 mm, Ø 2.2 mm
034.260		BLT Drill, short, guided, length 33.4 mm, Ø 2.8 mm
034.261		BLT Drill, medium, guided, length 37.4 mm, Ø 2.8 mm
034.262		BLT Drill, long, guided, length 41.4 mm, Ø 2.8 mm
034.263		BLT Drill, short, guided, length 33.4 mm, Ø 3.5 mm
034.264		BLT Drill, medium, guided, length 37.4 mm, Ø 3.5 mm
034.265		BLT Drill, long, guided, length 41.4 mm, Ø 3.5 mm
034.266		BLT Drill, short, guided, length 33.4 mm, Ø 4.2 mm
034.267		BLT Drill, medium, guided, length 37.4 mm, Ø 4.2 mm
034.268		BLT Drill, long, guided, length 41.4 mm, Ø 4.2 mm
034.354		Guided Adapter for Profile Drill, FIBA, H2, handpiece, stainless steel
034.355		Guided Adapter for Profile Drill, FIBA, H4, handpiece, stainless steel
034.356		Guided Adapter for Profile Drill, FIBA, H6, handpiece, stainless steel
034.357		Guided Adapter for Tap, FIBA, H2, handpiece, stainless steel
034.358		Guided Adapter for Tap, FIBA, H4, handpiece, stainless steel
034.359		Guided Adapter for Tap, FIBA, H6, handpiece, stainless steel
034.324		BLT Profile Drill, short, FIBA compatible, Ø 3.3 mm, L 27 mm, stainless steel
034.325		BLT Profile Drill, short, FIBA compatible, Ø 4.1 mm, L 27 mm, stainless steel
034.326		BLT Profile Drill, short, FIBA compatible, Ø 4.8 mm, L 27 mm, stainless steel

Alternatively, an X-Velodrill™ with a respective diameter can be used for BLT Guided Surgery.











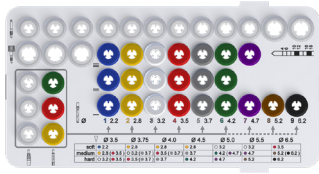

















Art. No.	Picture	Article
<b>B Module</b>		
034.345		BLT Tap, short, FIBA compatible, Ø 3.3 mm, L 21 mm, stainless steel
034.346		BLT Tap, short, FIBA compatible, Ø 4.1 mm, L 21 mm, stainless steel
034.347		BLT Tap, short, FIBA compatible, Ø 4.8 mm, L 21 mm, stainless steel
034.005		Connector for Ratchet
026.0083		BL/BLT Guided Adapter, for Handpiece
026.0084		BL/BLT Guided Adapter, for Ratchet
<b>C Module</b>		
041.772		Straumann® ModularCassette, C Module, Guided Surgery
026.0147		Drill Handle, Ø 2.2 mm, 1 mm/3 mm stop, stainless steel
026.0148		Drill Handle, Ø 2.8 mm, 1 mm/3 mm stop, stainless steel
026.0150		Drill Handle, Ø 3.5 mm, 1 mm/3 mm stop, stainless steel
026.0152		Drill Handle, Ø 4.2 mm, 1 mm/3 mm stop, stainless steel
034.284		Drill for Template Fixation Pin, Ø 1.3 mm
034.282		Template Fixation Pin, Ø 1.3 mm
034.298		Template Fixation Pin, Ø 2.8/2.8 mm, guided
034.285		Template Fixation Pin, Ø 5/2.8 mm, guided, stainless steel
034.287		Template Fixation Pin, Ø 5/3.5 mm, guided, stainless steel
034.289		Template Fixation Pin, Ø 5/4.2 mm, guided, stainless steel













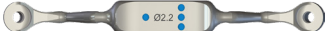
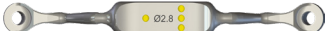
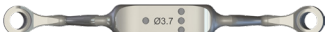

**Caution:**

Make sure that the right combination of sleeves and Drill handles is selected.

For more information go to Chapter 3.1.5 *Drill Handle* on page 20.

## 74 GUIDED SURGERY WITH BLX AND TLX IMPLANTS

Art. No.	Picture	Article
<b>B Module</b>		
041.776		Straumann® Modular Cassette, B Module
041.780		B Module, Guided Fully Tapered Tray
034.010		Mucosa Punch Ø3.4 mm, 30 mm, guided
034.011		Mucosa Punch Ø4.0 mm, 30 mm, guided
034.012		Mucosa Punch Ø4.7 mm, 30 mm, guided
034.215		Milling Cutter, Ø2.8 mm, 32.5 mm, guided
034.415		Milling Cutter, Ø3.5 mm, 32.5 mm, guided
034.615		Milling Cutter, Ø4.2 mm, 32.5 mm, guided
066.1301		Pilot VeloDrill™, guided, Ø2.2 mm, short
066.1302		VeloDrill™, guided, Ø2.8 mm, short, stainless steel
066.1303		VeloDrill™, guided, Ø3.2 mm, short, stainless steel
066.1304		VeloDrill™, guided, Ø3.5 mm, short, stainless steel
066.1305		VeloDrill™, guided, Ø3.7 mm, short, stainless steel
066.1306		VeloDrill™, guided, Ø4.2 mm, short, stainless steel
066.1307		VeloDrill™, guided, Ø4.7 mm, short, stainless steel
066.1308		VeloDrill™, guided, Ø5.2 mm, short, stainless steel
066.1309		VeloDrill™, guided, Ø6.2 mm, short, stainless steel
066.1501		Pilot VeloDrill™, guided, Ø2.2 mm, medium, stainless steel
066.1502		VeloDrill™, guided, Ø2.8 mm, medium, stainless steel
066.1503		VeloDrill™, guided, Ø3.2 mm, medium, stainless steel
066.1504		VeloDrill™, guided, Ø3.5 mm, medium, stainless steel
066.1505		VeloDrill™, guided, Ø3.7 mm, medium, stainless steel
066.1506		VeloDrill™, guided, Ø4.2 mm, medium, stainless steel
066.1701		Pilot VeloDrill™, guided, Ø2.2 mm, long, stainless steel
066.1702		VeloDrill™, guided, Ø2.8 mm, long, stainless steel
066.1703		VeloDrill™, guided, Ø3.2 mm, long, stainless steel
066.1704		VeloDrill™, guided, Ø3.5 mm, long, stainless steel
066.1705		VeloDrill™, guided, Ø3.7 mm, long, stainless steel
066.1706		VeloDrill™, guided, Ø4.2 mm, long, stainless steel
066.1707		VeloDrill™, guided, Ø4.7 mm, long, stainless steel

Art. No.	Picture	Article
<b>B Module</b>		
066.4403		BLX/BLC Guided Implant Driver, for handpiece, stainless steel
066.4404		BLX/BLC Guided Implant Driver, for ratchet, stainless steel
037.3000		TLX/TLC Guided Implant Driver, for ratchet, for TLX S, stainless steel
037.3001		TLX/TLC Guided Implant Driver, for handpiece, for TLX S, stainless steel
037.3002		TLX/TLC Guided Implant Driver, for ratchet, for TLX SP, stainless steel
037.3003		TLX/TLC Guided Implant Driver, for handpiece, for TLX SP, stainless steel
<b>C Module</b>		
041.772		Straumann® ModularCassette, C Module, Guided Surgery
026.0147		Drill Handle, Ø2.2 mm, 1 mm/3 mm stop, stainless steel
026.0148		Drill Handle, Ø2.8 mm, 1 mm/3 mm stop, stainless steel
026.0149		Drill Handle, Ø3.2 mm, 1 mm/3 mm stop, stainless steel
026.0150		Drill Handle, Ø3.5 mm, 1 mm/3 mm stop, stainless steel
026.0151		Drill Handle, Ø3.7 mm, 1 mm/3 mm stop, stainless steel
026.0152		Drill Handle, Ø4.2 mm, 1 mm/3 mm stop, stainless steel
034.284		Drill for Template Fixation Pin, Ø1.3 mm
034.282		Template Fixation Pin, Ø1.3 mm
034.298		Template Fixation Pin, Ø2.8/2.8 mm, guided
034.285		Template Fixation Pin, Ø5/2.8 mm, guided, stainless steel
034.286		Template Fixation Pin, Ø5/3.2 mm, guided, stainless steel
034.287		Template Fixation Pin, Ø5/3.5 mm, guided, stainless steel
034.288		Template Fixation Pin, Ø5/3.7 mm guided, stainless steel
034.289		Template Fixation Pin, Ø5/4.2 mm, guided, stainless steel
036.3300		RT Profile. Drill, short, for implants Ø3.75/Ø4.8 mm, stainless steel (TLX only)
036.3301		RT Profile Drill, long, for implants Ø3.75/Ø4.8 mm, stainless steel (TLX only)
036.3302		WT Profile Drill, short, for implants Ø5.5/Ø6.5 mm, stainless steel (TLX only)
036.3303		WT Profile Drill, long, for implants Ø5.5/Ø6.5 mm, stainless steel (TLX only)

**Caution:**

Make sure that the right combination of sleeves and Drill handles is selected.

For more information go to Chapter 3.1.5 *Drill Handle* on page 20.



### **International Headquarters**

Institut Straumann AG

Peter Merian-Weg 12

CH-4002 Basel, Switzerland

Phone +41 (0)61 965 11 11

Fax +41 (0)61 965 11 01

[www.straumann.com](http://www.straumann.com)

© Institut Straumann AG, 2024. All rights reserved.

Straumann® and/or other trademarks and logos from Straumann® mentioned herein are the trademarks or registered trademarks of Straumann Holding AG and/or its affiliates.

